

# Full Function Load Switch with Adjustable Current Limit

## FPF2163, FPF2164, FPF2165

### General Description

The FPF2163, FPF2164, and FPF2165 is a series of load switches which provides full protection to systems and loads which may encounter large current conditions. These devices contain a 0.12 Ω current-limited P-channel MOSFET which can operate over an input voltage range of 1.8 – 5.5 V. Internally, current is prevented from flowing when the MOSFET is off and the output voltage is higher than the input voltage. Switch control is by a logic input (ON) capable of interfacing directly with low voltage control signals. Each part contains thermal shutdown protection which shuts off the switch to prevent damage to the part when a continuous over-current condition causes excessive heating.

When the switch current reaches the current limit, the parts operate in a constant-current mode to prohibit excessive currents from causing damage. For the FPF2163 and FPF2164, if the constant current condition still persists after 30 ms, these parts will shut off the switch and pull the fault signal pin (FLAGB) low. The FPF2163 has an auto-restart feature which will turn the switch on again after 450 ms if the ON pin is still active. The FPF2164 does not have this auto-restart feature so the switch will remain off until the ON pin is cycled. The FPF2165 will not turn off after a current limit fault, but will rather remain in the constant current mode indefinitely. The minimum current limit is 150 mA.

These parts are available in a space-saving 6 pin 2X2 MLP package.

### Features

- 1.8 to 5.5 V Input Voltage Range
- Controlled Turn-On
- 0.15 – 1.5 A Adjustable Current Limit
- Undervoltage Lockout
- Thermal Shutdown
- <2 μA Shutdown Current
- Auto Restart
- Fast Current Limit Response Time
  - ◆ 5 μs to Moderate Over Currents
  - ◆ 30 ns to Hard Shorts
- Fault Blanking
- Reverse Current Blocking
- RoHS Compliant
- These are Pb-Free Devices

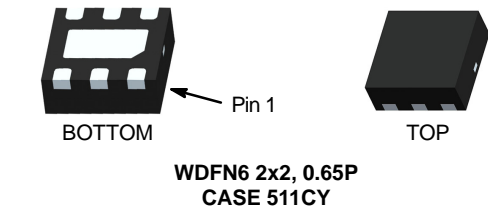

### MARKING DIAGRAM

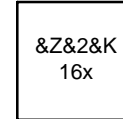

- &Z = Assembly Plant Code
- &2 = 2-Digit Date Code
- &K = 2-Digits Lot Run Traceability Code
- 16x = Device Code (x = 3, 4, 5)

### ORDERING INFORMATION

See detailed ordering and shipping information on page 12 of this data sheet.

### Applications

- PDAs
- Cell Phones
- GPS Devices
- MP3 Players
- Digital Cameras
- Peripheral Ports
- Hot Swap Supplies



# FPF2163, FPF2164, FPF2165

## PIN CONFIGURATION

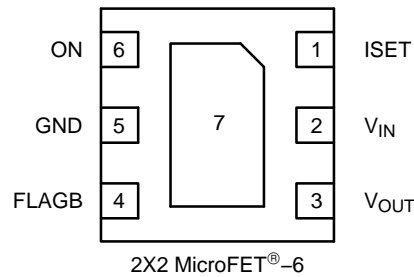

Figure 3. Pin Configuration

### PIN DESCRIPTION

Pin	Name	Function
1	ISET	Current Limit Set Input: A resistor from ISET to ground sets the current limit for the switch.
2	V <sub>IN</sub>	Supply Input: Input to the power switch and the supply voltage For the IC
3	V <sub>OUT</sub>	Switch Output: Output of the power switch
4	FLAGB	Fault Output: Active LO, open drain output which indicates an over current supply under voltage or over temperature state.
5, 7	GND	Ground
6	ON	ON Control Input

### ABSOLUTE MAXIMUM RATINGS

Parameter		Min	Max	Unit	
V <sub>IN</sub> , V <sub>OUT</sub> , ON, FLAGB, ISET to GND		-0.3	6	V	
Power Dissipation		-	1.2	W	
Operating and Storage Junction Temperature		-65	150	°C	
Thermal Resistance, Junction to Ambient		-	86	°C/W	
Electrostatic Discharge Protection	Jedec A114A	HBM	4000	-	V
	Jedec C101C	CDM	2000	-	V
	Jedec A115	MM	400	-	V
	IEC 61000-4-2	Air Discharge	15000	-	V
		Contact Discharge	8000	-	V

Stresses exceeding those listed in the Maximum Ratings table may damage the device. If any of these limits are exceeded, device functionality should not be assumed, damage may occur and reliability may be affected.

### RECOMMENDED OPERATING CONDITIONS

Parameter	Min	Max	Unit
V <sub>IN</sub>	1.8	5.5	V
Ambient Operating Temperature, T <sub>A</sub>	-40	85	°C

Functional operation above the stresses listed in the Recommended Operating Ranges is not implied. Extended exposure to stresses beyond the Recommended Operating Ranges limits may affect device reliability.

# FPF2163, FPF2164, FPF2165

**ELECTRICAL CHARACTERISTICS** ( $V_{IN} = 1.8$  to  $5.5$  V,  $T_A = -40$  to  $+85^\circ\text{C}$  unless otherwise noted. Typical values are at  $V_{IN} = 3.3$  V and  $T_A = 25^\circ\text{C}$ .)

Parameter	Symbol	Conditions	Min	Typ	Max	Unit	
<b>BASIC OPERATION</b>							
Operating Voltage	$V_{IN}$		1.8	–	5.5	V	
Quiescent Current	$I_Q$	$I_{OUT} = 0$ mA	$V_{IN} = 1.8$ V	–	63	100	$\mu\text{A}$
			$V_{IN} = 3.3$ V	–	68	–	
			$V_{IN} = 5.5$ V	–	77	120	
On-Resistance	$R_{ON}$	$V_{IN} = 3.3$ V, $I_{OUT} = 200$ mA, $T_A = 25^\circ\text{C}$	–	120	160	$\text{m}\Omega$	
		$V_{IN} = 3.3$ V, $I_{OUT} = 200$ mA, $T_A = 85^\circ\text{C}$	–	135	180		
		$V_{IN} = 3.3$ V, $I_{OUT} = 200$ mA, $T_A = -40^\circ\text{C}$ to $+85^\circ\text{C}$	65	–	180		
ON Input Logic High Voltage (ON)	$V_{IH}$	$V_{IN} = 1.8$ V	0.8	–	–	V	
		$V_{IN} = 5.5$ V	1.4	–	–		
ON Input Logic Low Voltage	$V_{IL}$	$V_{IN} = 1.8$ V	–	–	0.5	V	
		$V_{IN} = 5.5$ V	–	–	1		
ON Input Leakage		$V_{ON} = V_{IN}$ or GND	–1	–	1	$\mu\text{A}$	
$V_{IN}$ Shutdown Current		$V_{ON} = 0$ V, $V_{IN} = 5.5$ V, $V_{OUT} = \text{short to GND}$	–2	–	2	$\mu\text{A}$	
FLAGB Output Logic Low Voltage		$V_{IN} = 5$ V, $I_{SINK} = 10$ mA	–	0.05	0.2	V	
		$V_{IN} = 1.8$ V, $I_{SINK} = 10$ mA	–	0.12	0.3		
FLAGB Output High Leakage Current		$V_{IN} = 5$ V, Switch on	–	–	1	$\mu\text{A}$	

## REVERSE BLOCK

$V_{OUT}$ Shutdown Current		$V_{ON} = 0$ V, $V_{OUT} = 5.5$ V, $V_{IN} = \text{short to GND}$	–2	–	2	$\mu\text{A}$
----------------------------	--	---	----	---	---	---------------

## PROTECTIONS

Current Limit	$I_{LIM}$	$V_{IN} = 3.3$ V, $V_{OUT} = 3.0$ V, $R_{SET} = 345 \Omega$	600	800	1000	mA
Min. Current Limit	$I_{LIM(min.)}$	$V_{IN} = 3.3$ V, $V_{OUT} = 3.0$ V	–	150	–	mA
Thermal Shutdown		Shutdown Threshold	–	140	–	$^\circ\text{C}$
		Return from Shutdown	–	130	–	
		Hysteresis	–	10	–	
Under Voltage Shutdown	UVLO	$V_{IN}$ Increasing	1.55	1.65	1.75	V
Under Voltage Shutdown Hysteresis			–	50	–	mV

## DYNAMIC

Delay On Time	$t_{dON}$	$R_L = 500 \Omega$ , $C_L = 0.1 \mu\text{F}$	–	25	–	$\mu\text{s}$
Delay Off Time	$t_{dOFF}$	$R_L = 500 \Omega$ , $C_L = 0.1 \mu\text{F}$	–	45	–	$\mu\text{s}$
$V_{OUT}$ Rise Time	$t_{RISE}$	$R_L = 500 \Omega$ , $C_L = 0.1 \mu\text{F}$	–	10	–	$\mu\text{s}$
$V_{OUT}$ Fall Time	$t_{FALL}$	$R_L = 500 \Omega$ , $C_L = 0.1 \mu\text{F}$	–	110	–	$\mu\text{s}$
Over Current Blanking Time	$t_{BLANK}$	FPF2163, FPF2164	15	30	60	ms
Auto-Restart Time	$t_{RSTRT}$	FPF2163	225	450	900	ms
Short Circuit Response Time		$V_{IN} = V_{OUT} = 3.3$ V. Moderate Over-Current Condition.	–	5	–	$\mu\text{s}$
		$V_{IN} = V_{OUT} = 3.3$ V. Hard Short.	–	30	–	ns

Product parametric performance is indicated in the Electrical Characteristics for the listed test conditions, unless otherwise noted. Product performance may not be indicated by the Electrical Characteristics if operated under different conditions.

1. Package power dissipation on 1 square inch pad, 2 oz copper board.

# FPF2163, FPF2164, FPF2165

## TYPICAL CHARACTERISTICS

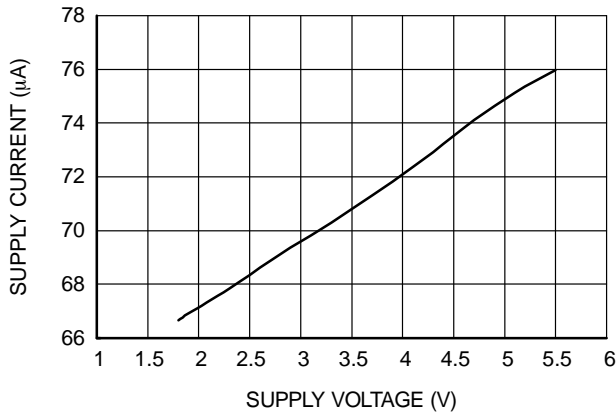

Figure 4. Quiescent Current vs. Input Voltage

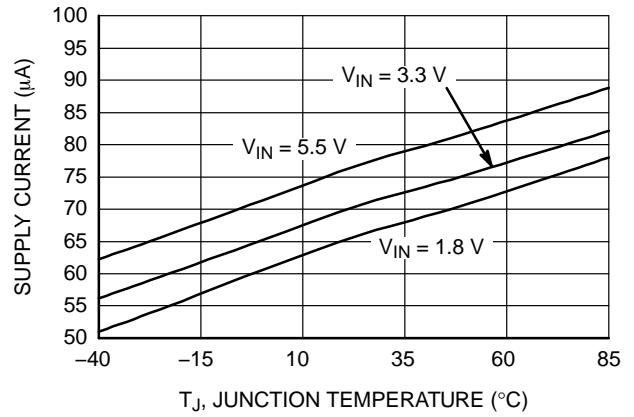

Figure 5. Quiescent Current vs. Temperature

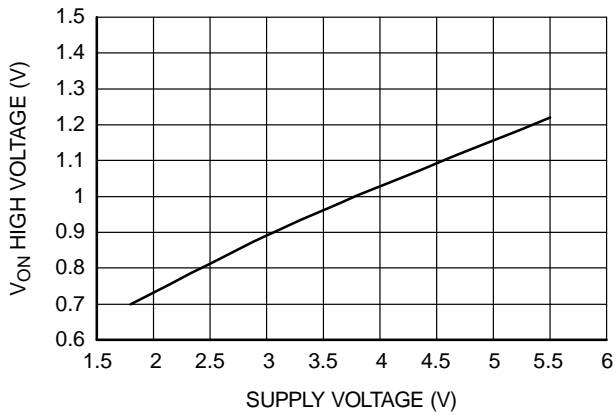

Figure 6. VON High Voltage vs. Input Voltage

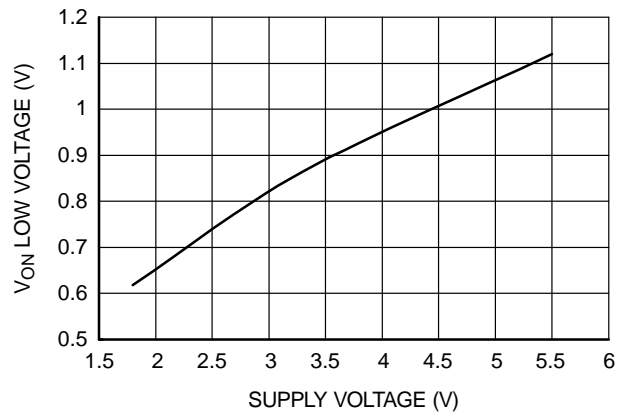

Figure 7. VON Low Voltage vs. Input Voltage

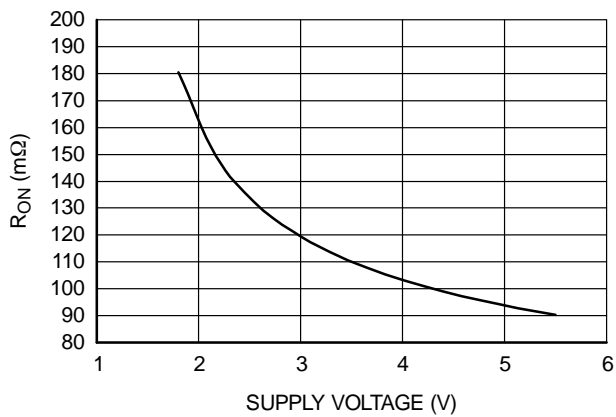

Figure 8. RON vs. VIN

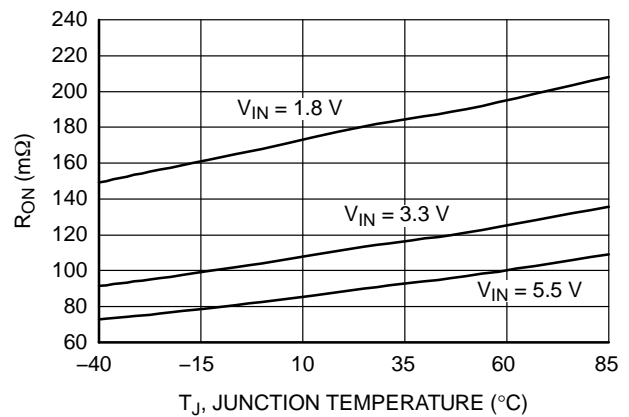

Figure 9. RON vs. Temperature

# FPF2163, FPF2164, FPF2165

## TYPICAL CHARACTERISTICS (continued)

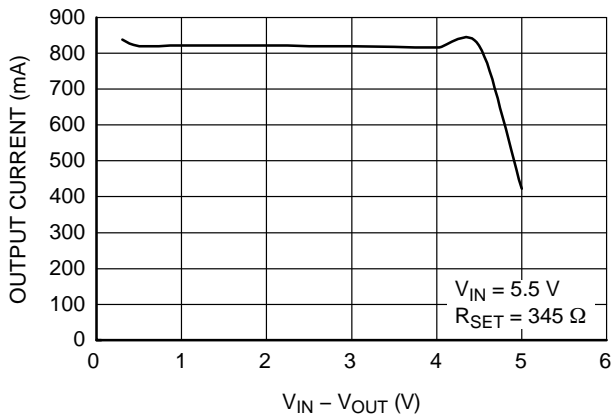

Figure 10. Current Limit vs. Output Voltage

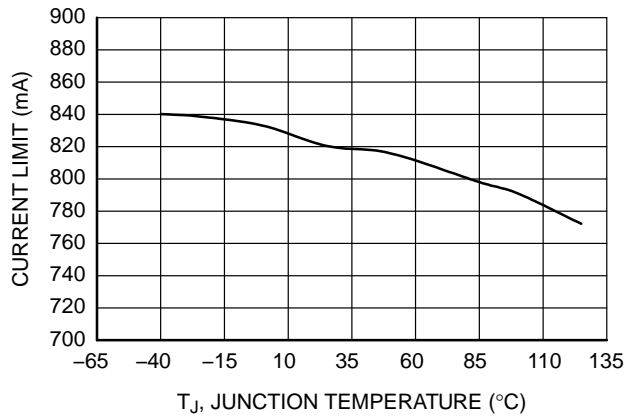

Figure 11. Current Limit vs. Temperature

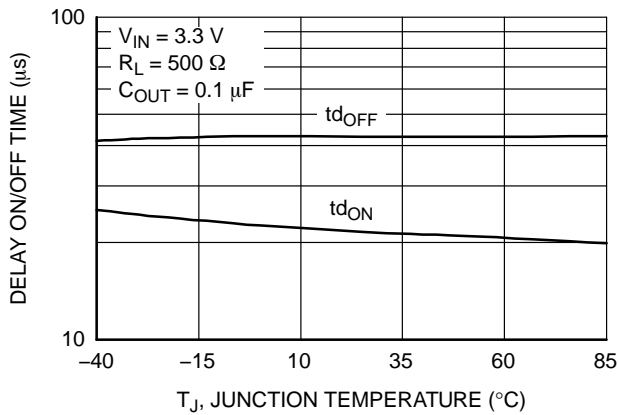

Figure 12.  $t_{dON}$  /  $t_{dOFF}$  vs. Temperature

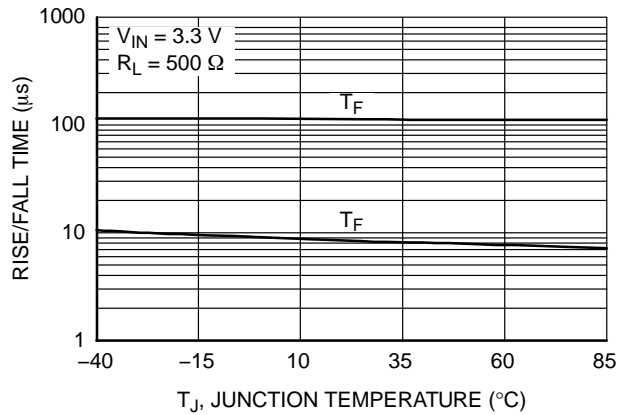

Figure 13.  $T_{RISE}$  /  $T_{FALL}$  vs. Temperature

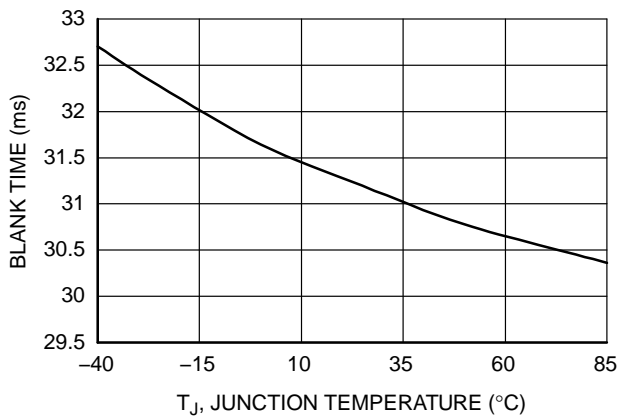

Figure 14.  $T_{BLANK}$  vs. Temperature

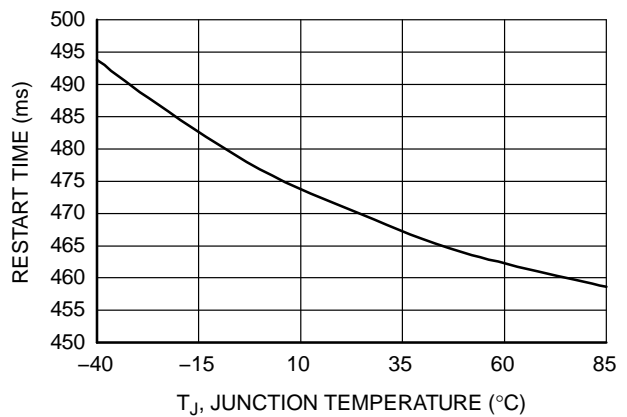

Figure 15.  $T_{RESTART}$  vs. Temperature

TYPICAL CHARACTERISTICS (continued)

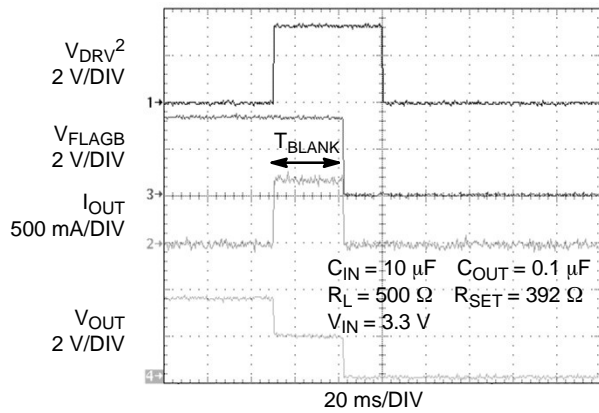

Figure 16.  $T_{BLANK}$  Response

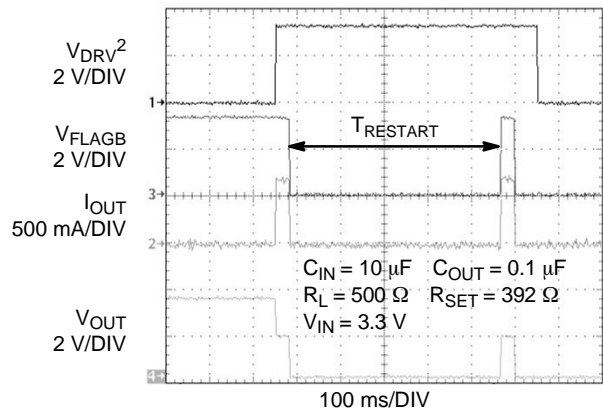

Figure 17.  $T_{RESTART}$  Response

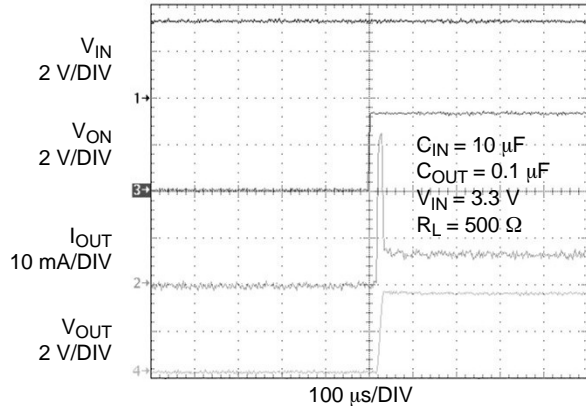

Figure 18.  $t_{dON}$  Response

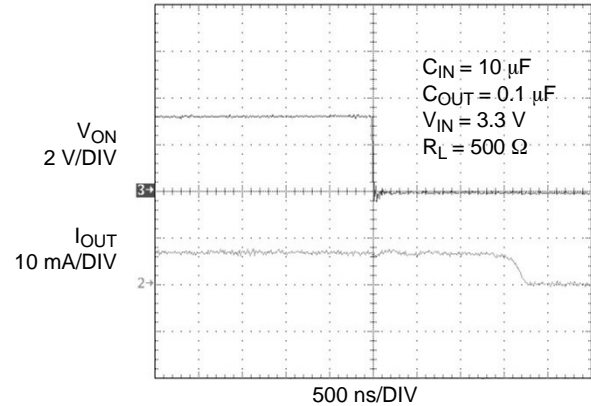

Figure 19.  $t_{dOFF}$  Response

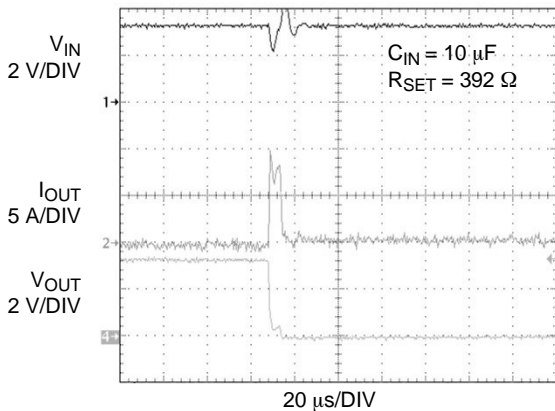

Figure 20. Short Circuit Response Time (Output Shorted to GND)

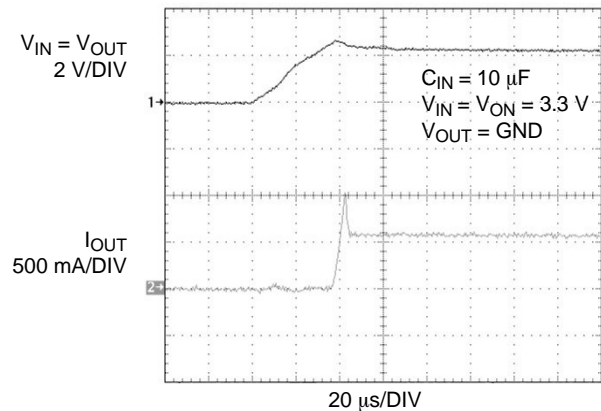
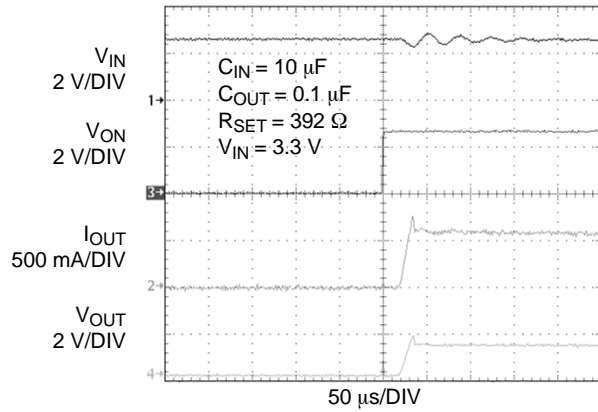

Figure 21. Current Limit Response Time (Switch is Powered into a Short)

# FPF2163, FPF2164, FPF2165

## TYPICAL CHARACTERISTICS (continued)



**Figure 22. Current Limit Response Time**  
(Output is Loaded by 2.2  $\Omega$ ,  $C_{OUT} = 0.1 \mu\text{F}$ )

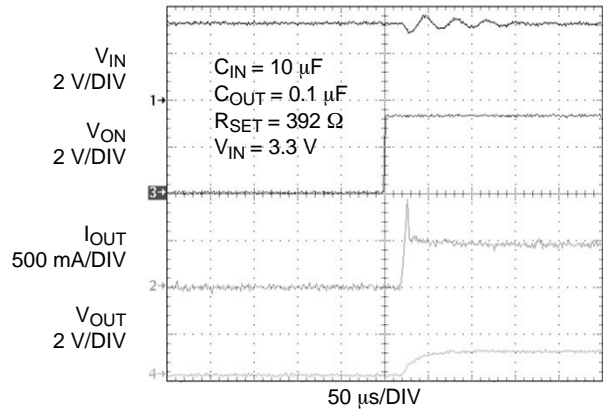

**Figure 23. Current Limit Response Time**  
(Output is Loaded by 2.2  $\Omega$ ,  $C_{OUT} = 10 \mu\text{F}$ )

**NOTE:**

2.  $V_{DRV}$  signal forces the device to go into overcurrent condition by loading.



## DESCRIPTION OF OPERATION

The FPF2163, FPF2164, and FPF2165 are current limited switches that protect systems and loads which can be damaged or disrupted by the application of high currents. The core of each device is a 0.12  $\Omega$  P-channel MOSFET and a controller capable of functioning over a wide input operating range of 1.8 – 5.5 V. The controller protects against system malfunctions through current limiting, undervoltage lockout and thermal shutdown. The current limit is adjustable from 150 mA to 1.5 A through the selection of an external resistor.

### On/Off Control

The ON pin controls the state of the switch. When ON is high, the switch is in the on state. Activating ON continuously holds the switch in the on state so long as there is no fault. For all versions, an undervoltage on  $V_{IN}$  or a junction temperature in excess of 140°C overrides the ON control to turn off the switch. In addition, excessive currents will cause the switch to turn off in the FPF2163 and FPF2164. The FPF2163 has an Auto-Restart feature which will automatically turn the switch on again after 450 ms. For the FPF2164, the ON pin must be toggled to turn-on the switch again. The FPF2165 does not turn off in response to an over current condition but instead remains operating in a constant current mode so long as ON is active and the thermal shutdown or undervoltage lockout have not activated.

The ON pin control voltage and  $V_{IN}$  pin have independent recommended operating ranges. The ON pin voltage can be driven by a voltage level higher than the input voltage.

### Fault Reporting

Upon the detection of an over-current, an input undervoltage, or an over-temperature condition, the FLAGB signals the fault mode by activating LO. For the FPF2163 and FPF2164, the FLAGB goes LO at the end of the blanking time while FLAGB goes LO immediately for the FPF2165. FLAGB remains LO through the Auto-Restart Time for the FPF2165. For the FPF2164, FLAGB is latched LO and ON must be toggled to release it. With the FPF2165, FLAGB is LO during the faults and immediately returns HI at the end of the fault condition. FLAGB is an open-drain MOSFET which requires a pull-up resistor between  $V_{IN}$  and FLAGB. During shutdown, the pull-down on FLAGB is disabled to reduce current draw from the supply.

### Current Limiting

The current limit ensures that the current through the switch doesn't exceed a maximum value while not limiting at less than a minimum value. The current at which the parts will limit is adjustable through the selection of an external

resistor connected to ISET. Information for selecting the resistor is found in the Application Info section. The FPF2163 and FPF2164 have a blanking time of 30 ms, nominally, during which the switch will act as a constant current source. At the end of the blanking time, the switch will be turned-off. The FPF2165 has no current limit blanking period so it will remain in a constant current state until the ON pin is deactivated or the thermal shutdown turns-off the switch.

For preventing the switch from large power dissipation during heavy load a short circuit detection feature is introduced. Short circuit condition is detected by observing the output voltage. The switch is put into short circuit current limiting mode if the switch is loaded with a heavy load. When the output voltage drops below  $V_{SCTH}$ , short circuit detection threshold voltage, the current limit value re-conditioned and short circuit current limit value is decreased to 62.5% of the current limit value. This keeps the power dissipation of the part below a certain limit even at dead short conditions at 5.5 V input voltage. The  $V_{SCTH}$  value is set to be 1 V. At around 1.1 V of output voltage the switch is removed from short circuit current limiting mode and the current limit is set to the current limit value.

### Undervoltage Lockout

The undervoltage lockout turns-off the switch if the input voltage drops below the undervoltage lockout threshold. With the ON pin active the input voltage rising above the undervoltage lockout threshold will cause a controlled turn-on of the switch which limits current over-shoots.

### Reverse Current Blocking

The entire FPF2163/65 family has a Reverse Current Blocking feature that protects input source against current flow from output to input. For a standard USB power design, this is an important feature which protects the USB host from being damaged due to reverse current flow on  $V_{BUS}$ . The reverse current blocking feature is active when the load switch is turned off.

If ON pin is LO and output voltage become greater than input voltage, no current can flow from the output to the input. The FLAGB operation is independent of the Reverse Current blocking feature and will not report a fault condition if this feature is activated.

### Thermal Shutdown

The thermal shutdown protects the die from internally or externally generated excessive temperatures. During an over-temperature condition the FLAGB is activated and the switch is turned-off. The switch automatically turns-on again if temperature of the die drops below the threshold temperature.

FPF2163, FPF2164, FPF2165

Timing Diagram

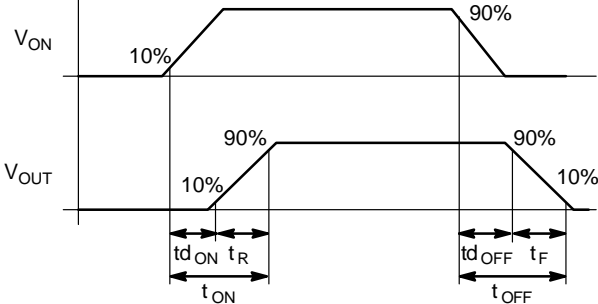

where:  
 $t_{dON}$  = Delay On Time  
 $t_R$  =  $V_{OUT}$  Rise Time  
 $t_{ON}$  = Turn On Time  
 $t_{dOFF}$  = Delay Off Time  
 $t_F$  =  $V_{OUT}$  Fall Time  
 $t_{OFF}$  = Turn Off Time

Figure 24. Timing Diagram

APPLICATION INFORMATION

Typical Application

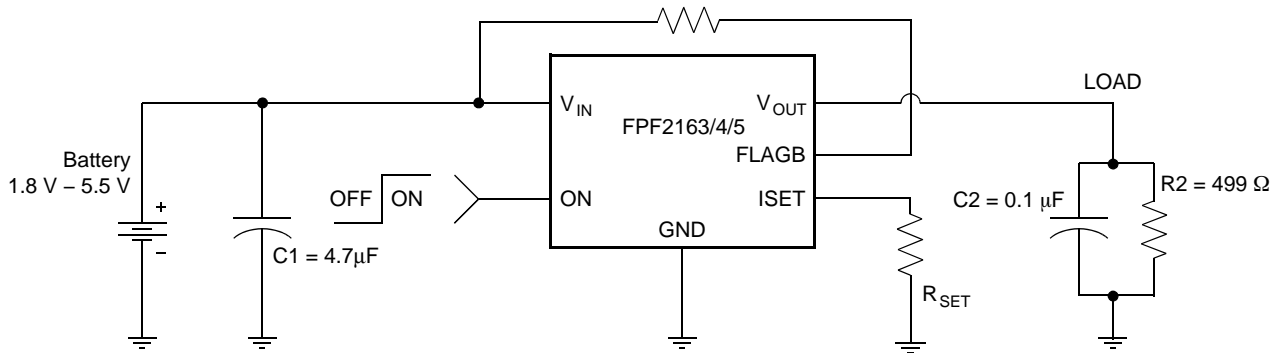

Figure 25. Typical Application

Setting Current Limit

The FPF2163, FPF2164, and FPF2165 have a current limit which is set with an external resistor connected between ISET and GND. This resistor is selected by using the following equation,

$$R_{SET} = \frac{275.6}{I_{LIM}} \quad (\text{eq. 1})$$

R<sub>SET</sub> is in Ohms and that of I<sub>LIM</sub> is Amps

The table below can also be used to select R<sub>SET</sub>. A typical application would be the 500 mA current that is required by a single USB port. Using the table below an appropriate selection for the R<sub>SET</sub> resistor would be 394 Ω. This will ensure that the port load could draw 525 mA, but not more than 875 mA. Likewise for a dual port system, an R<sub>SET</sub> of 185 Ω would always deliver at least 1125 mA and never more than 1875 mA.

CURRENT LIMIT VARIOUS R<sub>SET</sub> VALUES

R <sub>SET</sub> (Ω)	Min. Current Limit (mA)	Typ. Current Limit (mA)	Max. Current Limit (mA)
185	1125	1500	1875
220	938	1250	1562
275	750	1000	1250
306	675	900	1125
345	600	800	1000
394	525	700	875
460	450	600	750
550	375	500	625
610	338	450	563
690	300	400	500
790	263	350	438
920	225	300	375
1100	188	250	313
1380	150	200	250
1830	113	150	188

Input Capacitor

To limit the voltage drop on the input supply caused by transient in-rush currents when the switch is turned on into a discharged load capacitor or a short-circuit, a capacitor needs to be placed between V<sub>IN</sub> and GND. A 4.7 µF ceramic capacitor, C<sub>IN</sub>, must be placed close to the V<sub>IN</sub> pin. A higher value of C<sub>IN</sub> can be used to further reduce the voltage drop experienced as the switch is turned on into a large capacitive load.

Output Capacitor

A 0.1 µF capacitor C<sub>OUT</sub>, should be placed between V<sub>OUT</sub> and GND. This capacitor will prevent parasitic board inductances from forcing V<sub>OUT</sub> below GND when the switch turns-off. For the FPF2163 and FPF2164, the total output capacitance needs to be kept below a maximum value, C<sub>OUT(max)</sub>, to prevent the part from registering an over-current condition and turning-off the switch. The maximum output capacitance can be determined from the following formula,

$$C_{OUT(max)} = \frac{I_{LIM(max)} \times t_{BLANK(min)}}{V_{IN}} \quad (\text{eq. 2})$$

Power Dissipation

During normal operation as a switch, the power dissipated in the part will depend upon the level at which the current limit is set. The maximum allowed setting for the current limit is 1.5 A and this will result in a power dissipation of,

$$P = (I_{LIM})^2 \times R_{DS} = (1.5)^2 \times 0.12 = 270 \text{ mW} \quad (\text{eq. 3})$$

If the part goes into current limit the maximum power dissipation will occur when the output is shorted to ground. For the FPF2163, the power dissipation will scale by the Auto-Restart Time, t<sub>RSTRT</sub>, and the Over Current Blanking Time, t<sub>BLANK</sub>, so that the maximum power dissipated is,

$$P(max) = \frac{t_{BLANK}}{t_{BLANK} + t_{RSTRT}} \times V_{IN(max)} \times I_{LIM(max)}$$

$$= \frac{30}{30 + 450} \times 5.5 \times 1.5 = 515.6 \text{ mW} \quad (\text{eq. 4})$$

## FPF2163, FPF2164, FPF2165

This is more power than the package can dissipate, but the thermal shutdown of the part will activate to protect the part from damage due to excessive heating. When using the FPF2164, attention must be given to the manual resetting of the part. The junction temperature will only be able to increase to the thermal shutdown threshold. Once this temperature has been reached, toggling ON will not turn-on the switch until the junction temperature drops. For the FPF2165, a short on the output will cause the part to operate in a constant current state dissipating a worst case power of,

$$\begin{aligned}
 P(\text{max}) &= V_{\text{IN}}(\text{max}) \times I_{\text{LIM}}(\text{max}) \\
 &= 5.5 \times 1.5 = 8.25 \text{ W}
 \end{aligned}
 \tag{eq. 5}$$

This large amount of power will activate the thermal shutdown and the part will cycle in and out of thermal shutdown so long as the ON pin is active and the short is present.

### Board Layout

For best performance, all traces should be as short as possible. To be most effective, the input and output capacitors should be placed close to the device to minimize the effects that parasitic trace inductances may have on normal and short-circuit operation. Using wide traces for  $V_{\text{IN}}$ ,  $V_{\text{OUT}}$  and GND will help minimize parasitic electrical effects along with minimizing the case to ambient thermal impedance.

The middle pad (pin 7) should be connected to the GND plate of PCB for improving thermal performance of the load switch. An improper layout could result higher junction temperature and triggering the thermal shutdown protection feature. This concern applies when the switch is set at higher current limit value and an overcurrent condition occurs. In this case power dissipation of the switch ( $P_{\text{D}} = (V_{\text{IN}} - V_{\text{OUT}}) \times I_{\text{LIM}}(\text{max})$ ) could exceed the maximum absolute power dissipation of 1.2 W.

### ORDERING INFORMATION

Part	Top Mark	Current Limit (mA)	Current Limit Blanking Time (ms)	Auto-Restart Time (ms)	ON Pin Activity	Package Type	Shipping†
FPF2163	163	150 – 1500	15/30/60	225/450/900	Active HI	WDFN6 2x2, 0.65P (Pb-Free)	3000 / Tape & Reel
FPF2164	164	150 – 1500	15/30/60	NA	Active HI		3000 / Tape & Reel
FPF2165	165	150 – 1500	0	NA	Active HI		3000 / Tape & Reel

†For information on tape and reel specifications, including part orientation and tape sizes, please refer to our Tape and Reel Packaging Specifications Brochure, BRD8011/D.

# MECHANICAL CASE OUTLINE

## PACKAGE DIMENSIONS

ON Semiconductor®



WDFN6 2x2, 0.65P  
CASE 511CY  
ISSUE O

DATE 31 JUL 2016

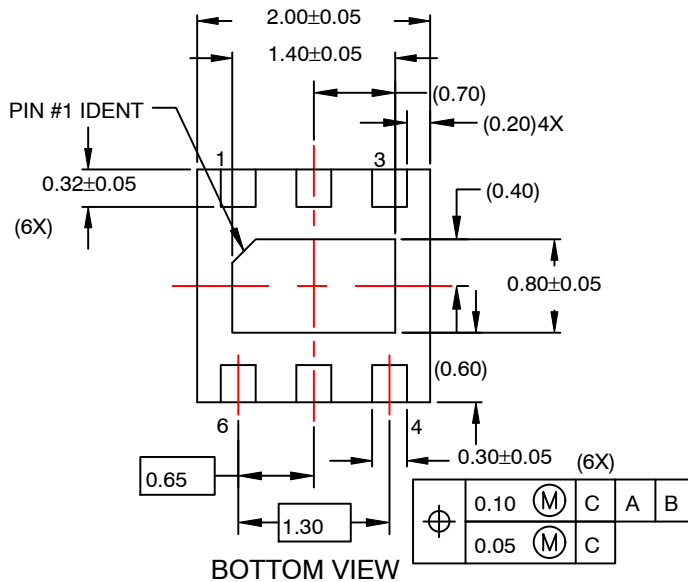
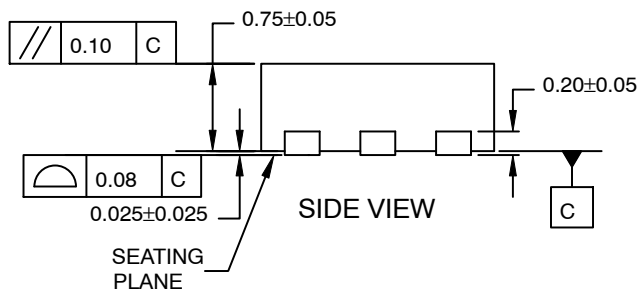
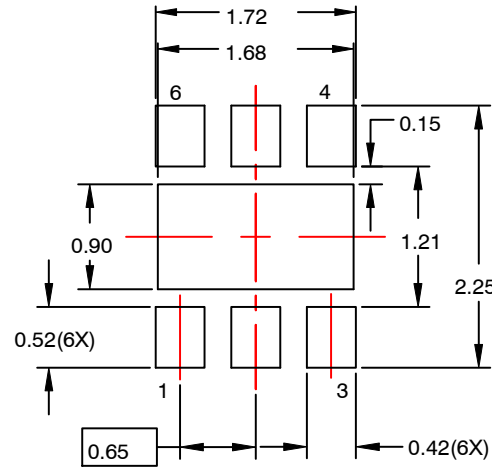
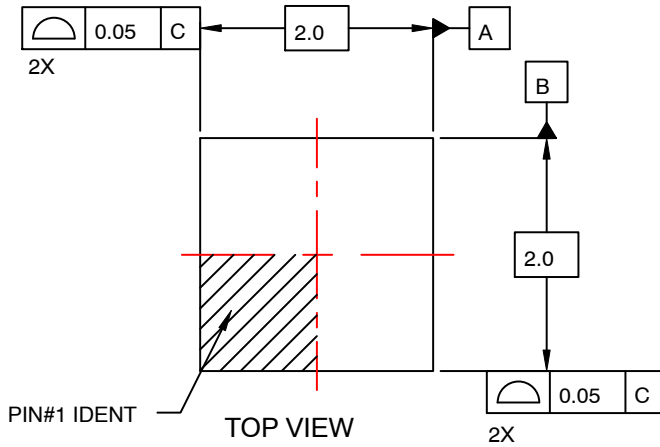

NOTES:

- A. PACKAGE DOES NOT FULLY CONFORM TO JEDEC MO-229 REGISTRATION
- B. DIMENSIONS ARE IN MILLIMETERS.
- C. DIMENSIONS AND TOLERANCES PER ASME Y14.5M, 2009.
- D. LAND PATTERN RECOMMENDATION IS EXISTING INDUSTRY LAND PATTERN.

<b>DOCUMENT NUMBER:</b>	<b>98AON13613G</b>	Electronic versions are uncontrolled except when accessed directly from the Document Repository. Printed versions are uncontrolled except when stamped "CONTROLLED COPY" in red.
<b>DESCRIPTION:</b>	<b>WDFN6 2X2, 0.65P</b>	<b>PAGE 1 OF 1</b>

ON Semiconductor and are trademarks of Semiconductor Components Industries, LLC dba ON Semiconductor or its subsidiaries in the United States and/or other countries. ON Semiconductor reserves the right to make changes without further notice to any products herein. ON Semiconductor makes no warranty, representation or guarantee regarding the suitability of its products for any particular purpose, nor does ON Semiconductor assume any liability arising out of the application or use of any product or circuit, and specifically disclaims any and all liability, including without limitation special, consequential or incidental damages. ON Semiconductor does not convey any license under its patent rights nor the rights of others.

**onsemi**, **Onsemi**, and other names, marks, and brands are registered and/or common law trademarks of Semiconductor Components Industries, LLC dba "**onsemi**" or its affiliates and/or subsidiaries in the United States and/or other countries. **onsemi** owns the rights to a number of patents, trademarks, copyrights, trade secrets, and other intellectual property. A listing of **onsemi**'s product/patent coverage may be accessed at [www.onsemi.com/site/pdf/Patent-Marking.pdf](http://www.onsemi.com/site/pdf/Patent-Marking.pdf). **onsemi** reserves the right to make changes at any time to any products or information herein, without notice. The information herein is provided "as-is" and **onsemi** makes no warranty, representation or guarantee regarding the accuracy of the information, product features, availability, functionality, or suitability of its products for any particular purpose, nor does **onsemi** assume any liability arising out of the application or use of any product or circuit, and specifically disclaims any and all liability, including without limitation special, consequential or incidental damages. Buyer is responsible for its products and applications using **onsemi** products, including compliance with all laws, regulations and safety requirements or standards, regardless of any support or applications information provided by **onsemi**. "Typical" parameters which may be provided in **onsemi** data sheets and/or specifications can and do vary in different applications and actual performance may vary over time. All operating parameters, including "Typicals" must be validated for each customer application by customer's technical experts. **onsemi** does not convey any license under any of its intellectual property rights nor the rights of others. **onsemi** products are not designed, intended, or authorized for use as a critical component in life support systems or any FDA Class 3 medical devices or medical devices with a same or similar classification in a foreign jurisdiction or any devices intended for implantation in the human body. Should Buyer purchase or use **onsemi** products for any such unintended or unauthorized application, Buyer shall indemnify and hold **onsemi** and its officers, employees, subsidiaries, affiliates, and distributors harmless against all claims, costs, damages, and expenses, and reasonable attorney fees arising out of, directly or indirectly, any claim of personal injury or death associated with such unintended or unauthorized use, even if such claim alleges that **onsemi** was negligent regarding the design or manufacture of the part. **onsemi** is an Equal Opportunity/Affirmative Action Employer. This literature is subject to all applicable copyright laws and is not for resale in any manner.

## ADDITIONAL INFORMATION

### TECHNICAL PUBLICATIONS:

Technical Library: [www.onsemi.com/design/resources/technical-documentation](http://www.onsemi.com/design/resources/technical-documentation)  
onsemi Website: [www.onsemi.com](http://www.onsemi.com)

### ONLINE SUPPORT: [www.onsemi.com/support](http://www.onsemi.com/support)

For additional information, please contact your local Sales Representative at [www.onsemi.com/support/sales](http://www.onsemi.com/support/sales)