

# 15 W SiC High-Voltage Auxiliary Power Supply for HEV & BEV Applications Evaluation Board User's Manual



ON Semiconductor®

[www.onsemi.com](http://www.onsemi.com)

## SECO-HVDCDC1362-15W-GEVB

## EVAL BOARD USER'S MANUAL

### Introduction

SECO-HVDCDC1362-15W-GEVB is highly efficient and primary-side regulated (PSR) auxiliary power supply targeting HEV and EV automotive power trains. The design provides a stable 15 V output and 15 W over a wide input DC voltage range from 250 V to 900 V, and is therefore suitable for 400 V and 800 V battery systems.

The board employs the NCV1362 quasi-resonant peak current PSR flyback controller, the 3-lead cost-optimized NVHL160N120SC1 160 mΩ 1200 V silicon carbide (SiC) MOSFET, and the FFSD0665B-F085 SiC diode.

Thanks to the high blocking voltage capabilities and ultra-low gate charge (34 nC) value of the SiC FET, the switching losses are significantly reduced, and the board exhibits a superior efficiency for the application up to 86% in low line input conditions. The notable driving capabilities of the NCV1362 controller allows for direct operation of the SiC FET at 12V without a pre-driver, simplifying the layout and cutting down the component count.

The flyback transformer provides 4 kV isolation and is optimized to minimize the losses on the RCD snubber. Consequently the system effectively dampens the drain voltage overshoot at high line, and provides 100 V margin for the SiC FET. The board is fully realized with automotive qualified semiconductors and passive devices. Industrial grade replacements are also available.

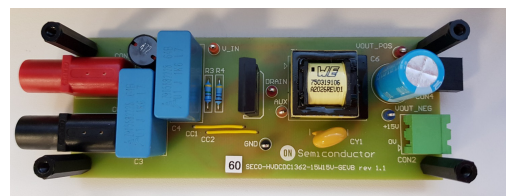

(Top View)

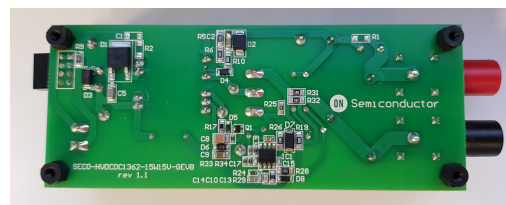

(Bottom View)

Figure 1. Board Layout

### Features

- NCV1362 (Automotive) / NCP1362 (Industrial) Quasi-resonant Peak Current PSR Flyback Controller
- Fully Automotive Qualified Devices
- $V_{in} = 240\text{ V} - 900\text{ V DC}$  Only
- $V_{out} = 15\text{ V} / 15\text{ W}$  Continuous
- Electromagnetic Compatibility (EN 55015 Limits)
- High Efficiency up to 86%
- SiC FET Directly Operated at 12 V by the IC
- Excellent Thermal Performance

### Applications

- HEV & EV Vehicles Auxiliary Power Supplies
- Automotive Powertrain Systems
- EV Charging and DC-DC Conversion
- Industrial DC-DC Conversion, Solar Inverts (with Industrial Grade)

### Benefits

- Superior Efficiency with SiC Devices
- Stable Performance across a Wide Input Voltage Range (250 Vdc – 900 Vdc)
- Reduced Bill-of-Material and Cost-optimized
- Fully AEC-Q Qualified Parts
- EMC within EN 55015 Limits
- Single Layer PCB

### Collateral

- [NVHL160N120SC1](#)
- [NCV1362](#)
- [SECO-HVDCDC1362-15W-GEVB](#)
- [References](#)

# SECO-HVDCDC1362-15W-GEVB

## Scope and Purpose

The purpose of this user's manual is to present the design of an auxiliary power supply with automotive qualified parts NCV1362 (NCP1362) and NVHL160N120SC1 SiC FET. The design was tested as described in this document but not

qualified regarding safety requirements or manufacturing and operation over the complete operating temperature range or lifetime. The hardware is intended for testing under laboratory conditions and by trained specialists only.

## System Overview

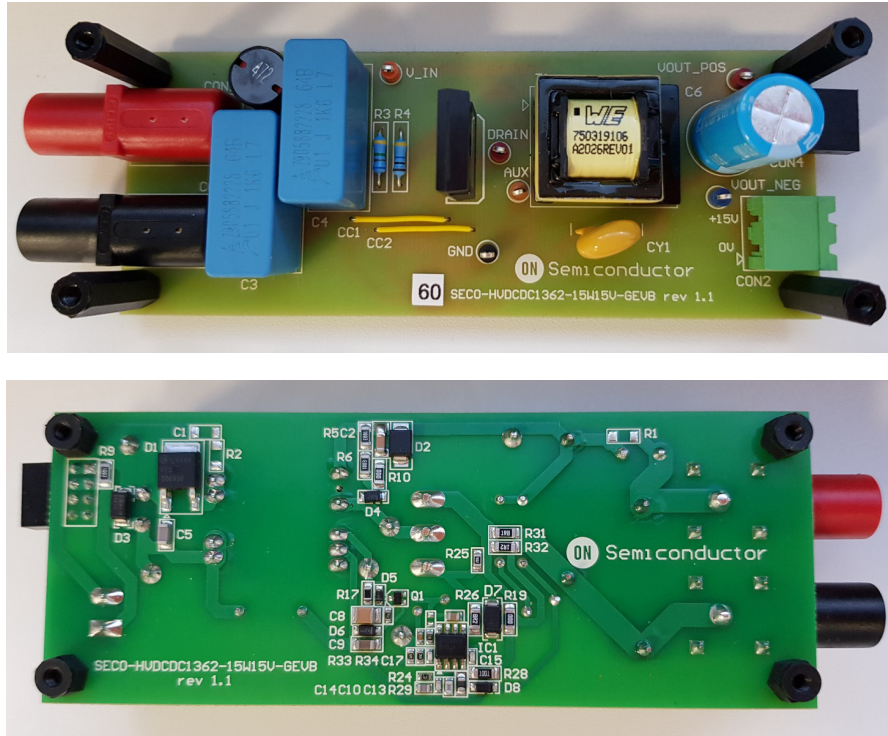

Figure 2. Evaluation Board Photo

## Block Diagram

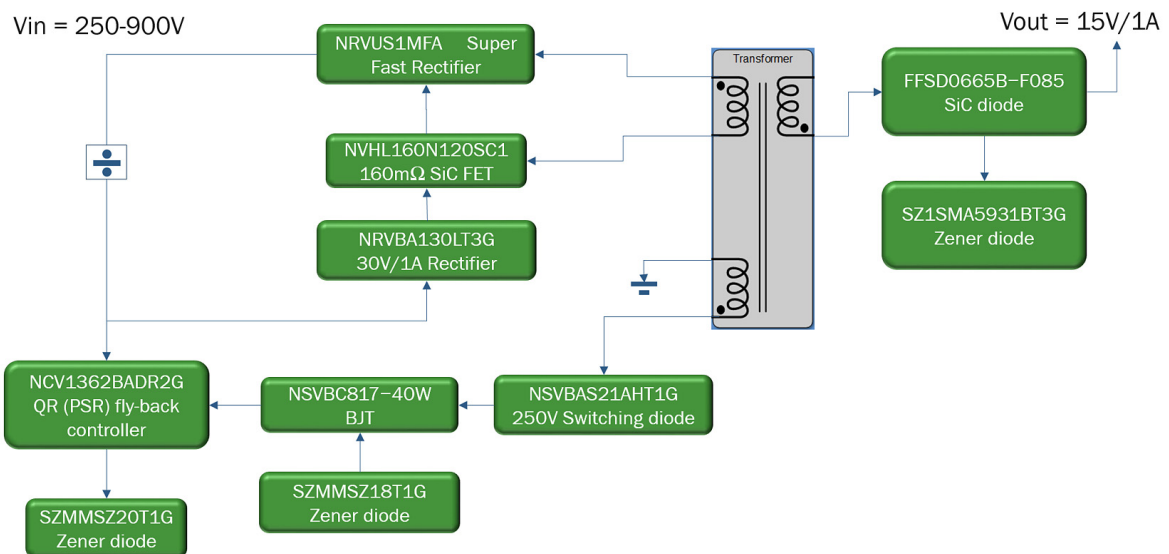

Figure 3. Block Diagram

# SECO-HVDCDC1362-15W-GEVB

## SPECIFICATION

Parameters	Values
<b>Input</b>	
Voltage	250-900 VDC
Current	71 mA ( $V_{in} = 250$ V), 22 mA ( $V_{in} = 900$ V)
<b>Output</b>	
Power	15 W
Voltage	15 VDC
Current per branch	1 A
Total current	1 A
Efficiency at full load	86% ( $V_{in} = 250$ V)
Temperature at full load	98°C ( $V_{in} = 6$ V), 74.5°C ( $V_{in} = 15$ V), 76°C ( $V_{in} = 18$ V)
<b>Control</b>	
Core part	NCV1362
Topology	Flyback
Switching frequency	50 kHz
Operation mode	DCM
Primary side peak current	0.65 A
<b>Construction</b>	
Board size	26.24 x 16.38 x 16.06 mm
<b>Transformer</b>	
Dielectric insulation	4000 VAC, 1 min.
Inductance	1.70 mH $\pm$ 10%
Leakage inductance	20 $\mu$ H typ. / 40 $\mu$ H max.
Safety standard	IEC62368-1
Pollution degree	1
<b>Application</b>	
HEV & EV vehicles, automotive powertrain systems, EV charging and DC-DC conversion	

# SECO-HVDCDC1362-15W-GEVB

## Schematic

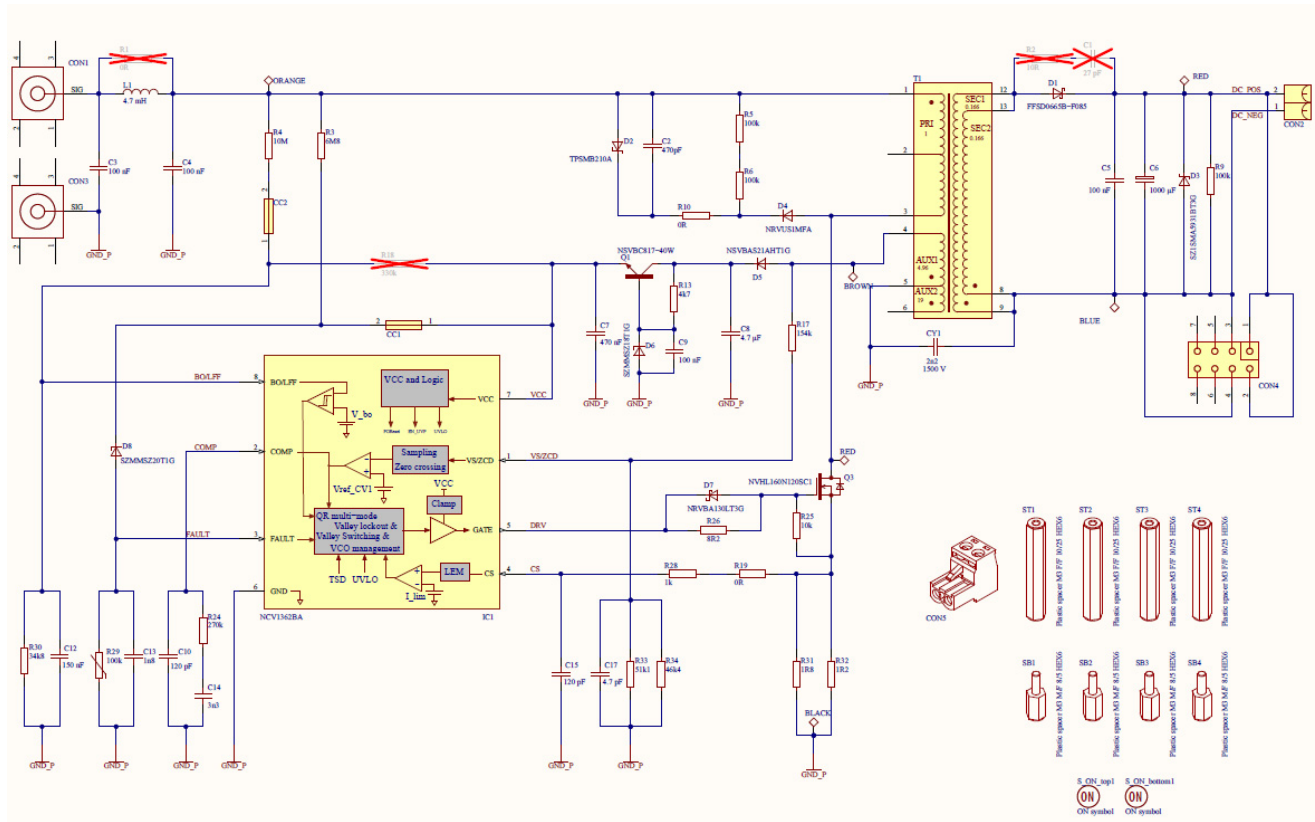

Figure 4. Evaluation Board Schematic

## TEST REPORT

This section presents the results of the tests conducted on the power supply.

- Efficiency DC/DC at input voltage range and full load
- Waveforms at 240V, 500V, 900V at full load / open circuit
- Load transients 15%–85% and 15%–85% load
- Thermal camera view
- Electromagnetic compatibility

### Efficiency DC/DC at Input Voltage Range and Full Load

Measured conditions:

- Output power  $P_{out} \sim 15\text{ W}$
- Electronic load: Chroma 6147A used channel 3 as CRH (constant resistance high mode  $15\ \Omega \rightarrow 1.0\text{ A}$ )

List of equipment:

- DC source: Magna-Power 0–1000V
- Power analyzer: Textronix PA3000
- Electronic load: Chroma

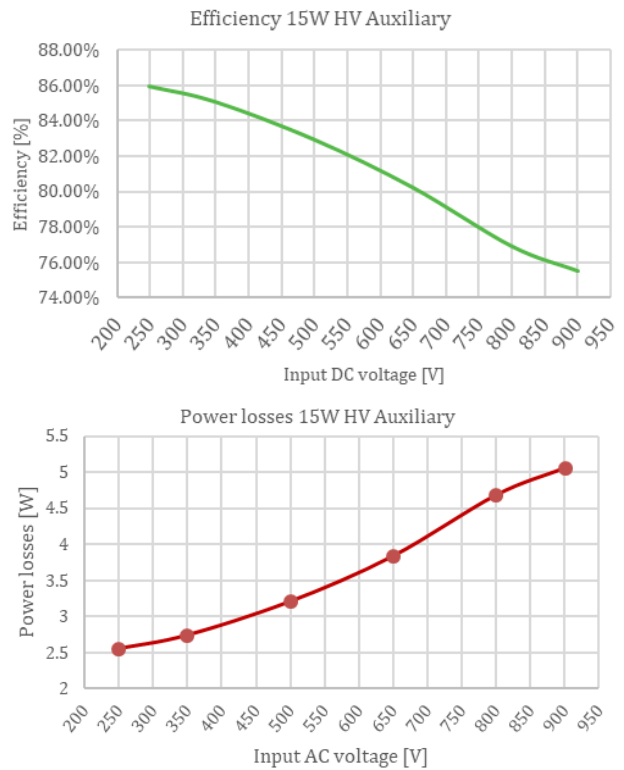

Figure 5.

# SECO-HVDCDC1362-15W-GEVB

## Waveforms at 240 V, 500 V, 900 V at Full Load / Open Circuit

Measured conditions:

- Output power  $P_{out} \sim 15\text{ W}$
- Electronic load: Chroma 6147A used channel 3 as CRH (constant resistance high mode 15 Ohm  $\rightarrow$  1.0A)

List of equipment:

- DC source: Magna-Power 0-1000V
- Power analyzer: Textronix PA3000
- Electronic load: Chroma
- Oscilloscope: Lecroy HDO8038

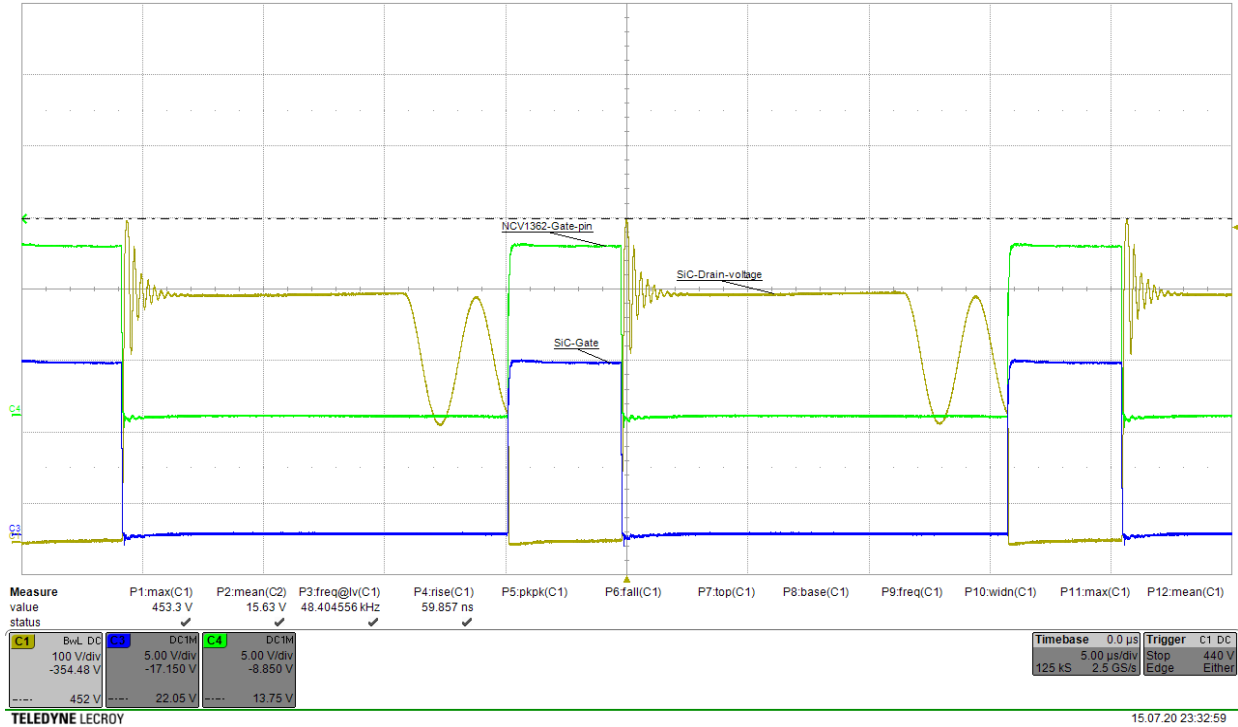

Figure 6. 250 V DC Full Load

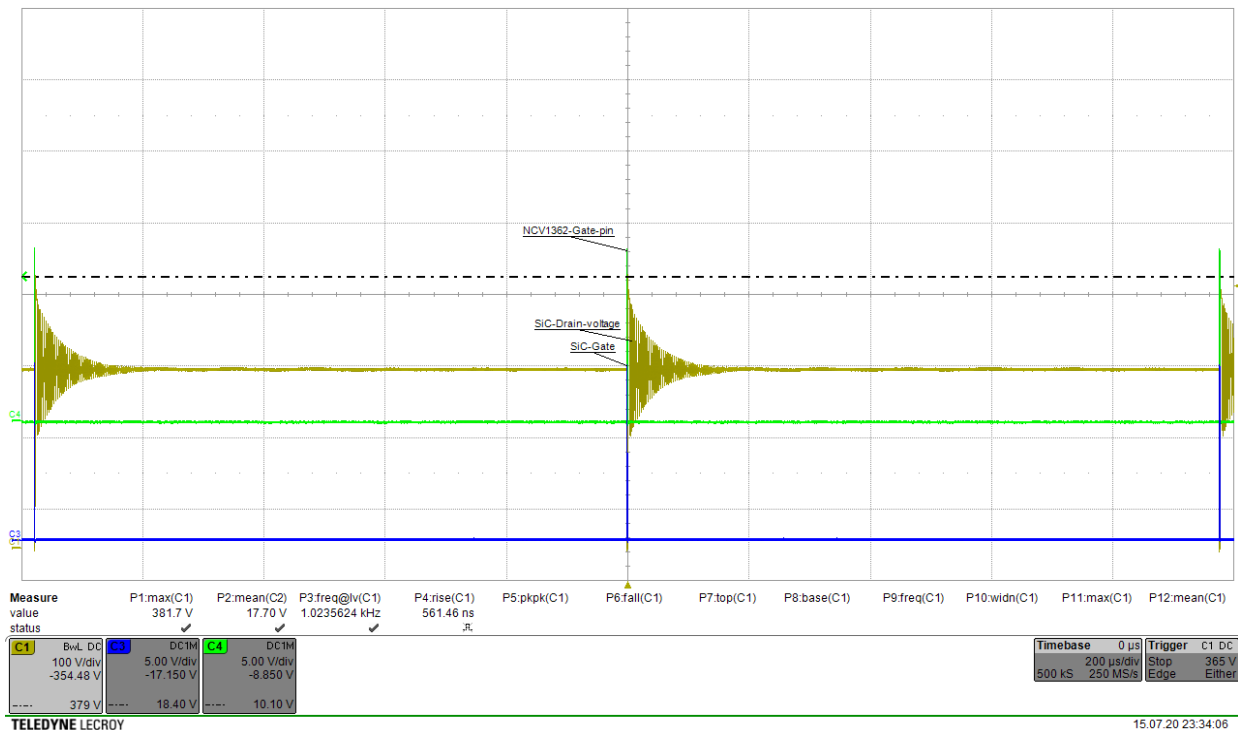

Figure 7. 250 V DC Open Circuit

# SECO-HVDCDC1362-15W-GEVB

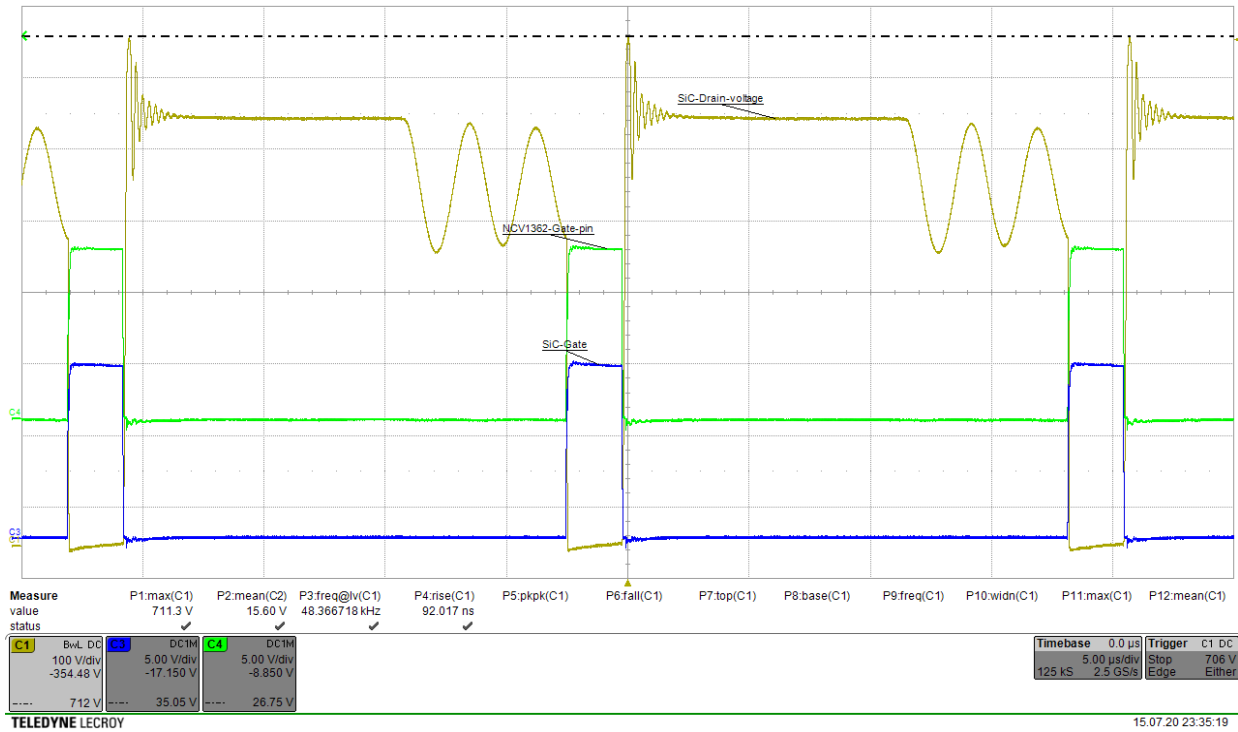

Figure 8. 500 V DC Full Load

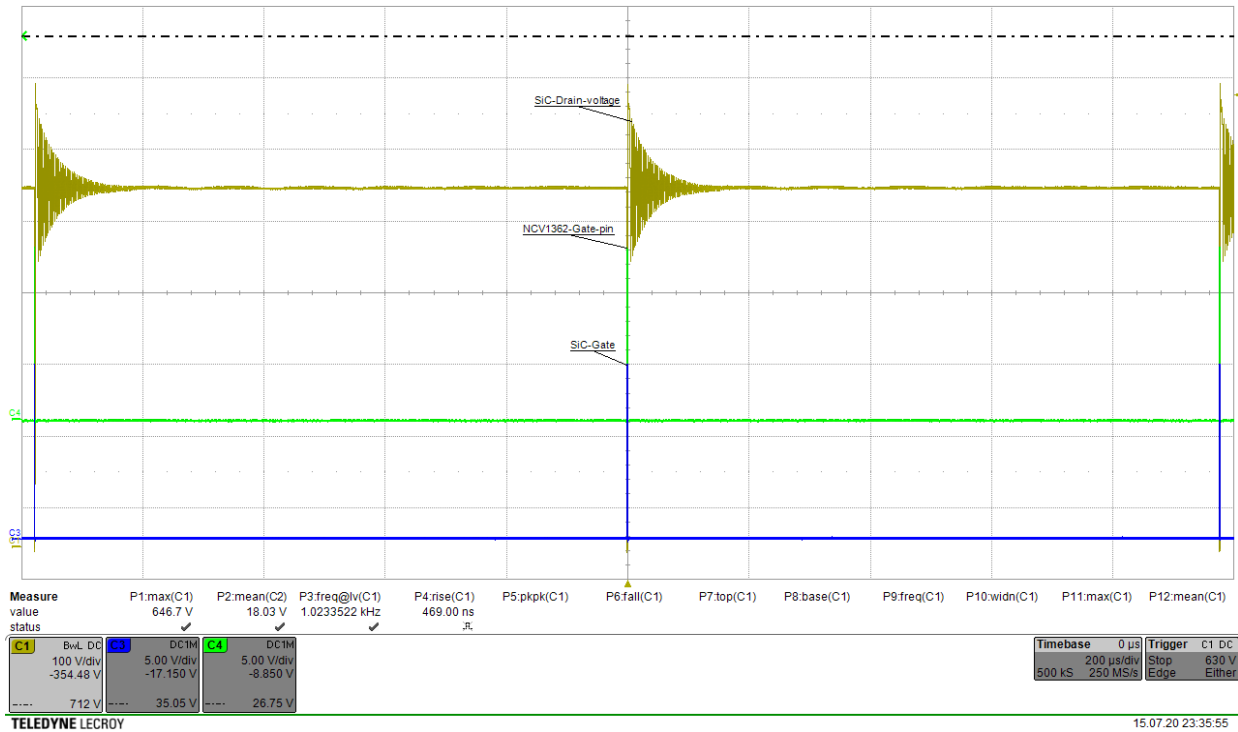

Figure 9. 500 V DC Open Circuit

# SECO-HVDCDC1362-15W-GEVB

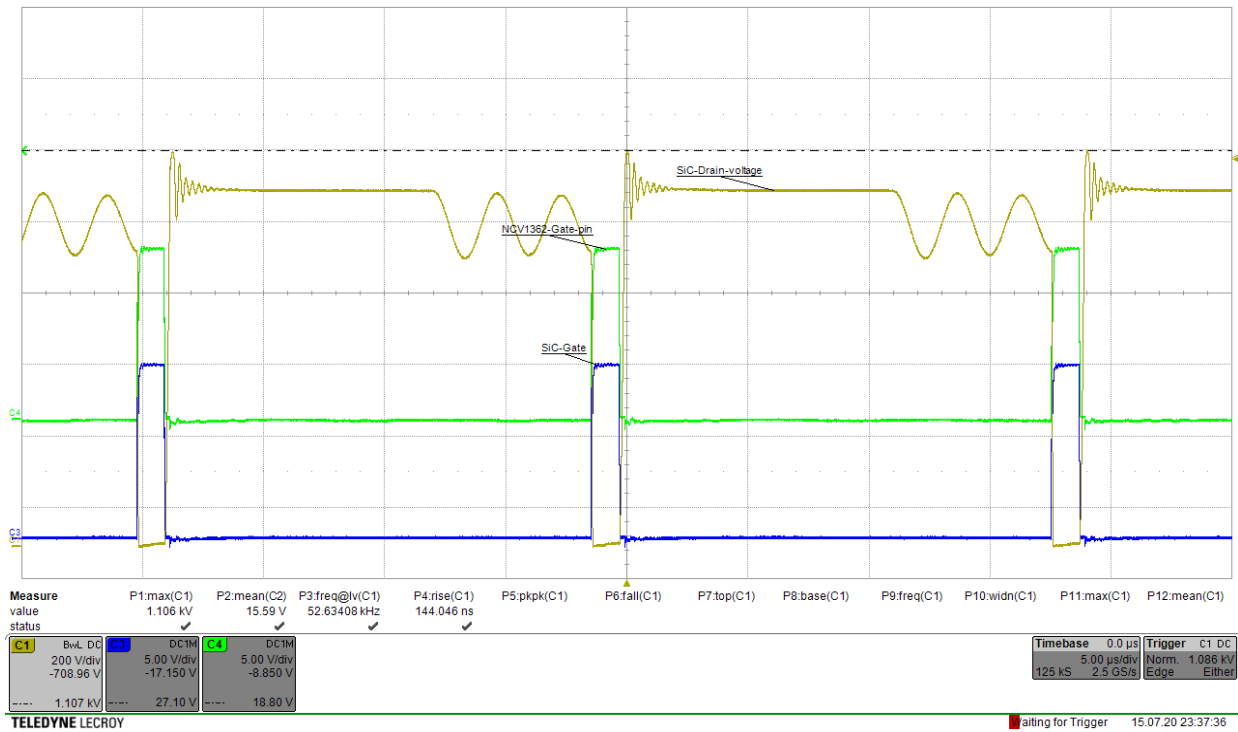

Figure 10. 900 V DC Full Load

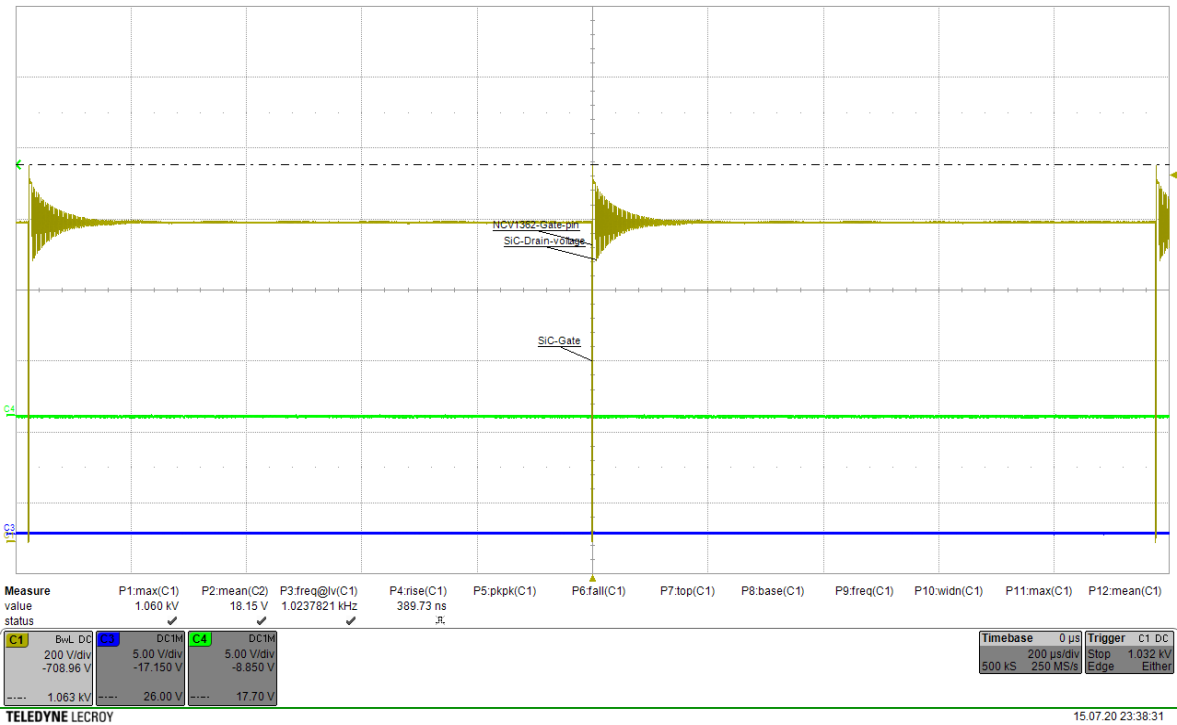

Figure 11. 900 V DC Open Circuit

# SECO-HVDCDC1362-15W-GEVB

## Load Transients 15%–85% and 15%–85% Load

Measured conditions:

- Output power  $P_{out} \sim 15\text{ W}$
- Electronic load: Chroma 6147A used channel 3 as CCDL (constant current dynamic mode 0.15 A  $\rightarrow$  0.85 A)

List of equipment:

- DC source: Magna-Power 0–1000V
- Power analyzer: Textronix PA3000
- Electronic load: Chroma
- Oscilloscope: Lecroy HDO8038

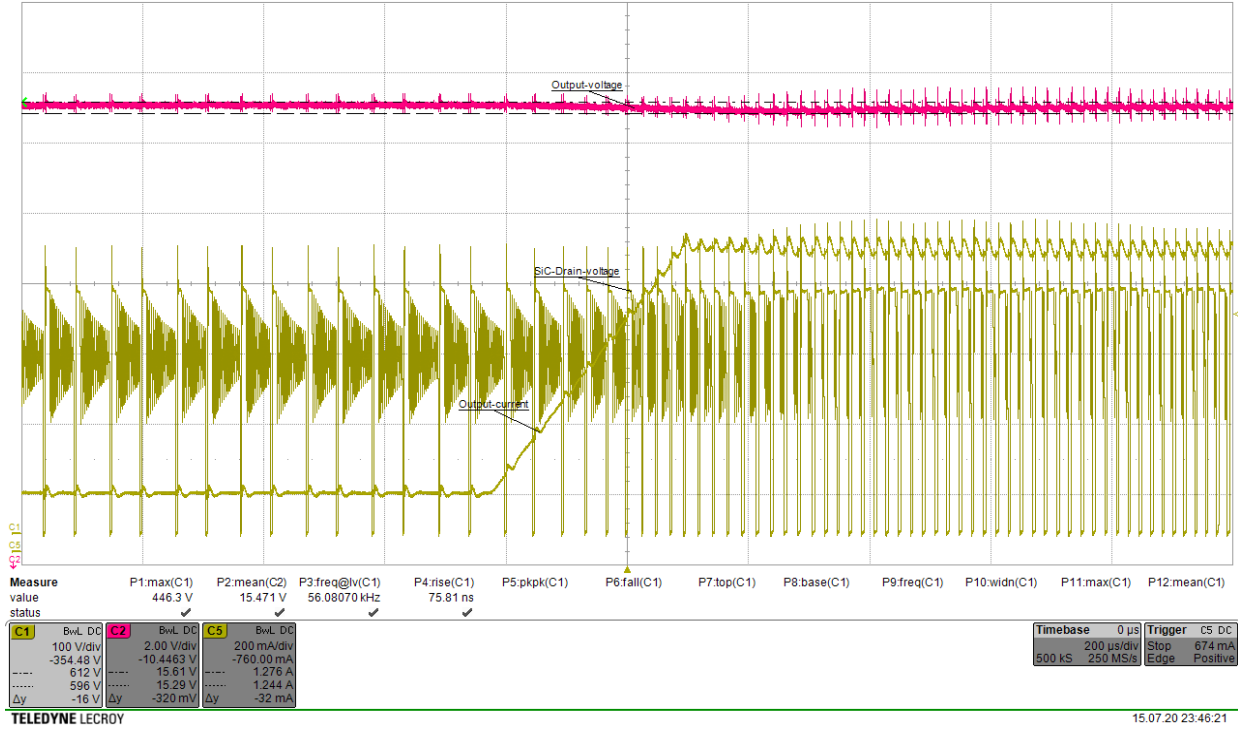

Figure 12. 250 V – 15% to 85%

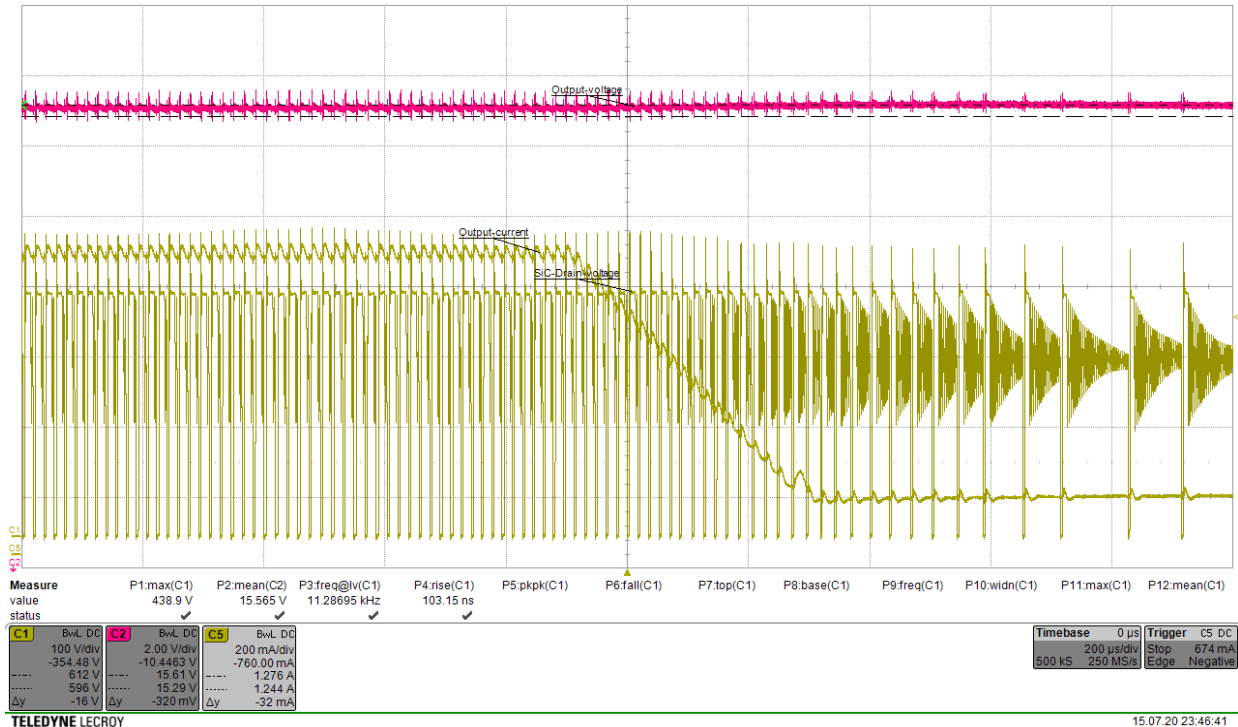

Figure 13. 250 V – 85% to 15%



# SECO-HVDCDC1362-15W-GEVB

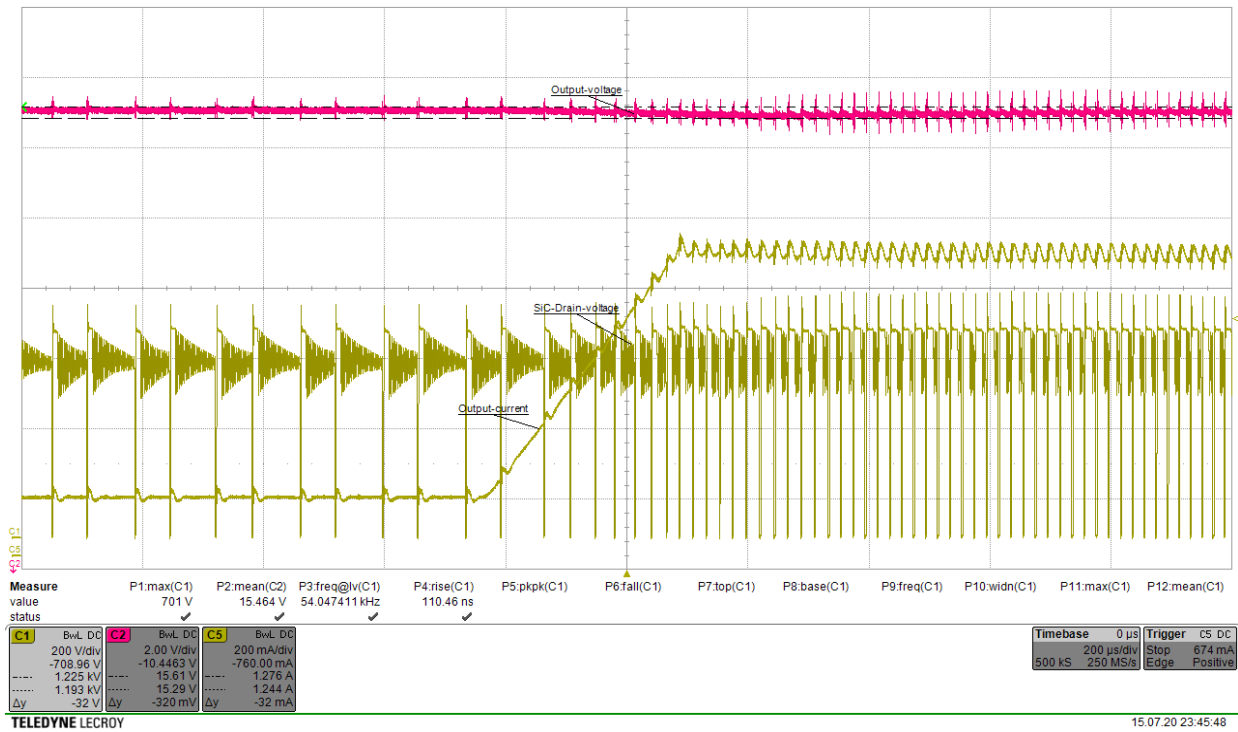

Figure 14. 500 V – 15% to 85%

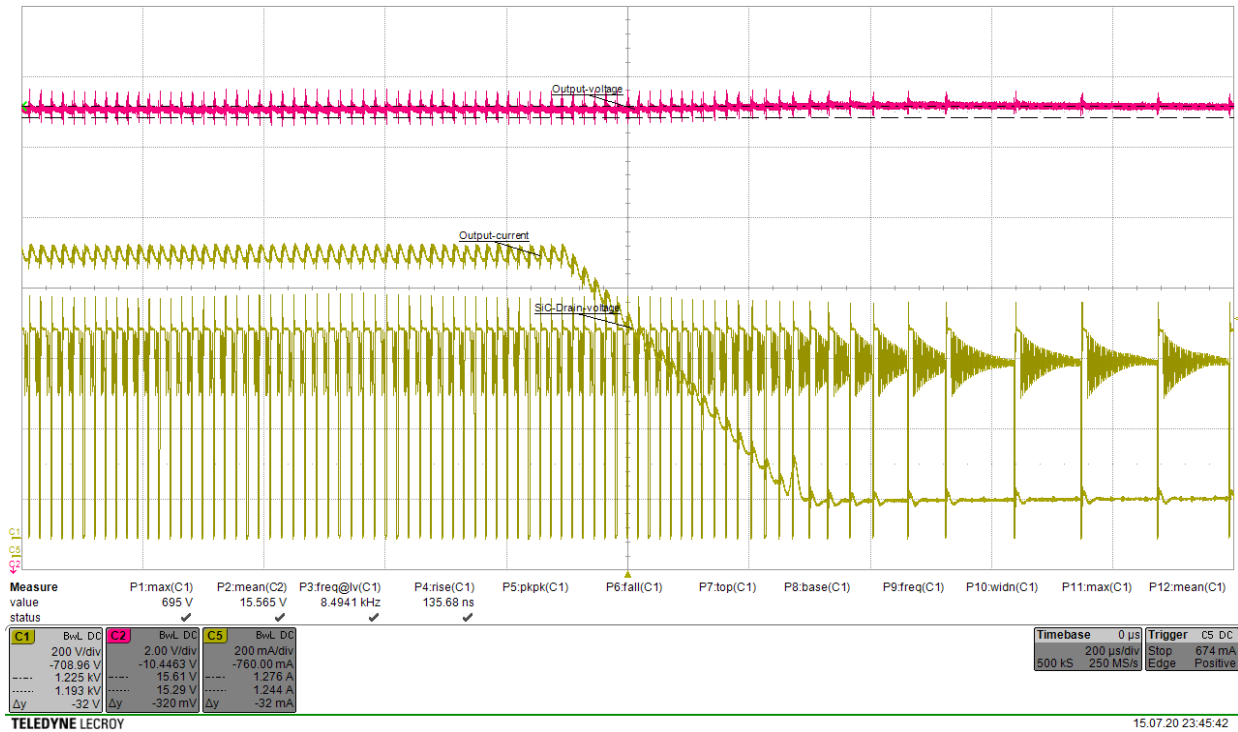

Figure 15. 500 V – 85% to 15%

# SECO-HVDCDC1362-15W-GEVB

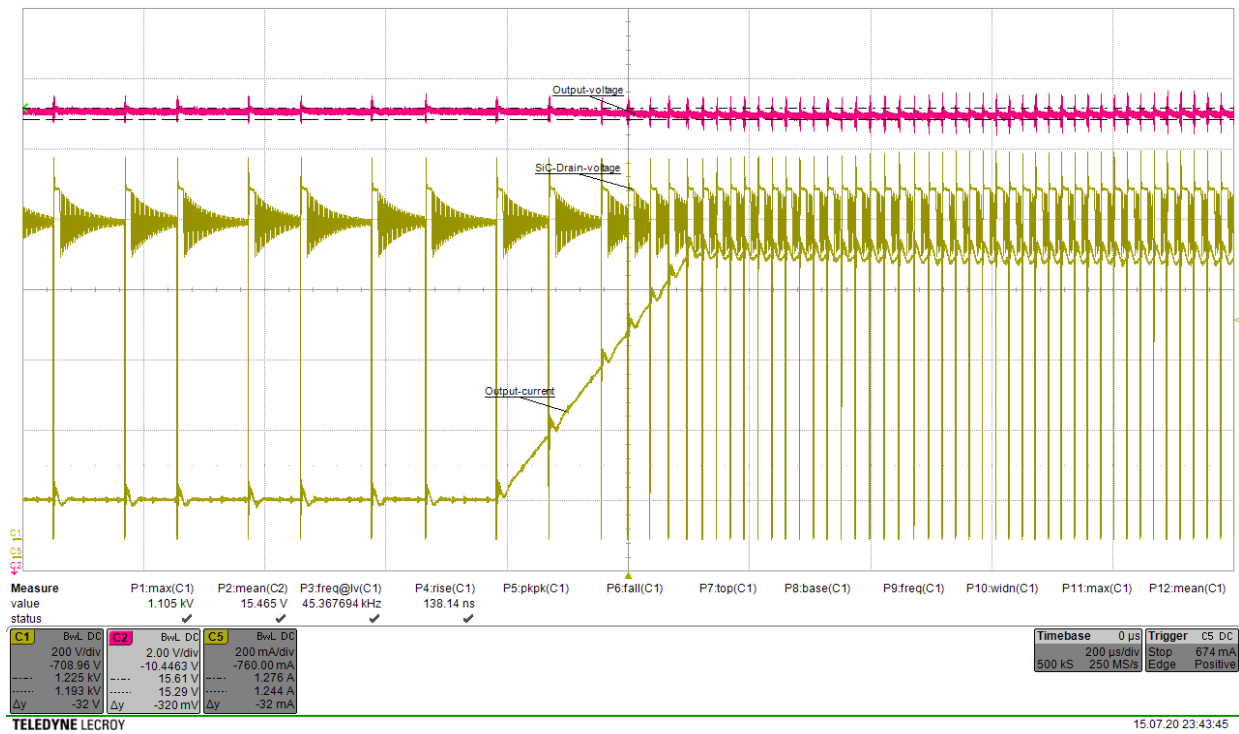

Figure 16. 900 V – 15% to 85%

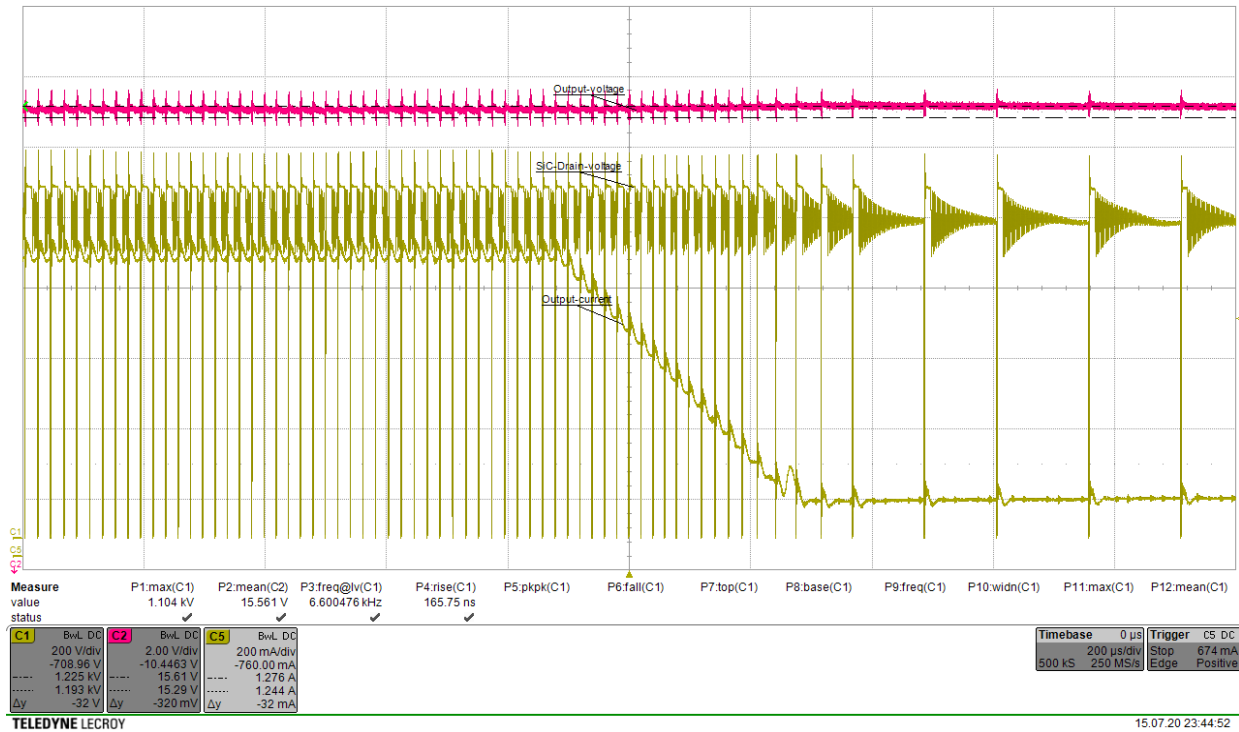

Figure 17. 900 V – 85% to 15%

## SECO-HVDCDC1362-15W-GEVB

### Thermal Camera View

Measured conditions:

- Output power  $P_{out} \sim 15\text{ W}$
- Electronic load: Chroma 6147A used channel 3 as CRH (constant resistance high mode  $15\ \Omega \rightarrow 1.0\text{ A}$ )
- Input voltage  $\sim 900\text{ V DC}$
- After 5 minutes in this conditions

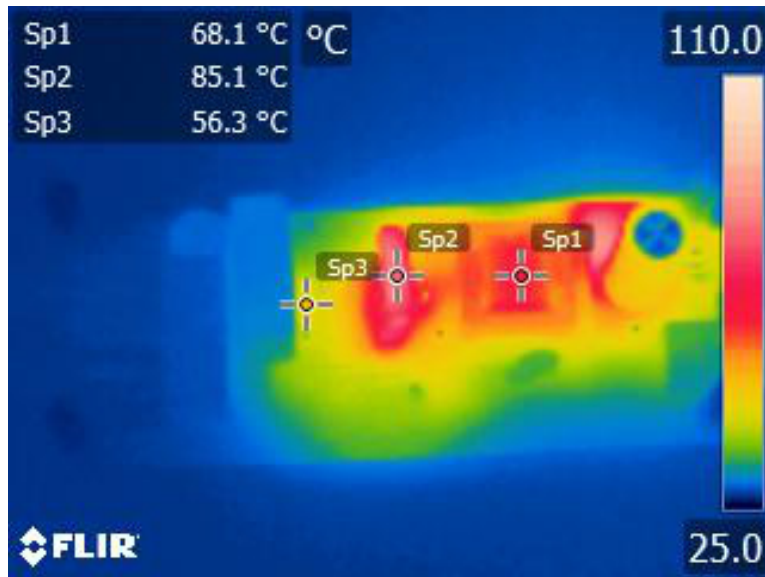

Sp1 – Transformer  
Sp2 – SiC switcher  
Sp3 – Startup high voltage resistor

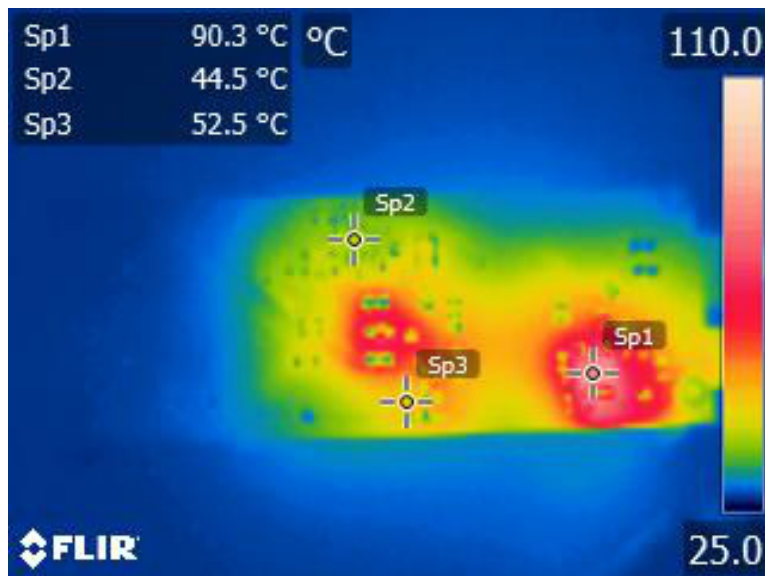

Sp1 – Secondary rectifier  
Sp2 – IC NCV 1362  
Sp3 – Snubber TVS diode

Figure 18.

## SECO-HVDCDC1362-15W-GEVB

Measured conditions:

- Output power  $P_{out} \sim 15\text{ W}$
- Electronic load: Chroma 6147A used channel 3 as CRH (constant resistance high mode  $15\ \Omega \rightarrow 1.0\text{ A}$ )
- Input voltage  $\sim 250\text{ V DC}$
- After 5 minutes in this conditions

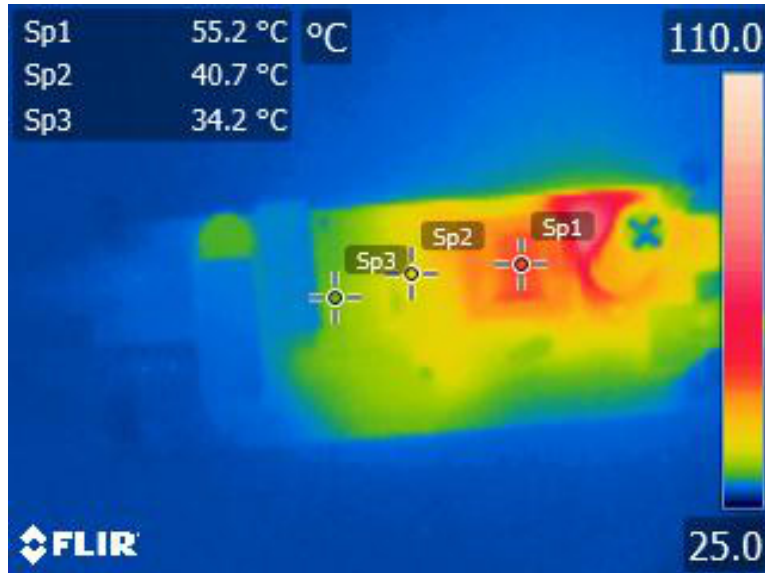

Sp1 – Transformer  
Sp2 – SiC switcher  
Sp3 – Startup high voltage resistor

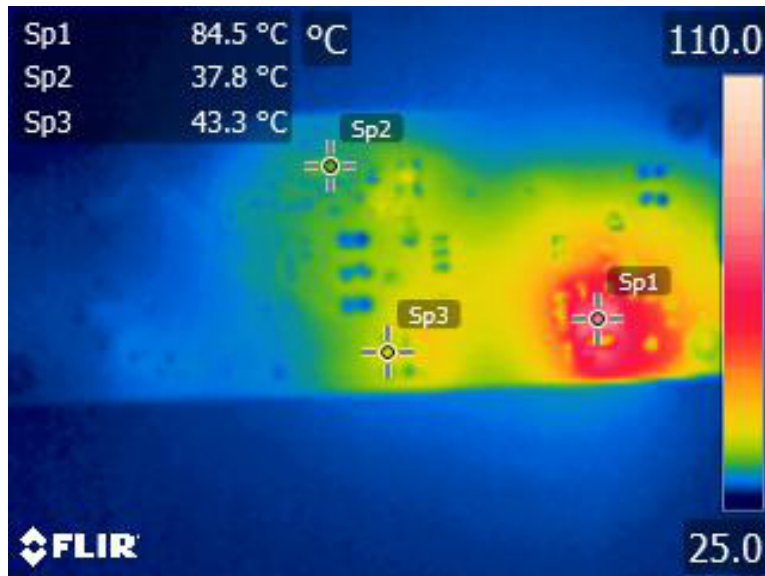

Sp1 – Secondary rectifier  
Sp2 – IC NCV 1362  
Sp3 – Snubber TVS diode

Figure 19.

# SECO-HVDCDC1362-15W-GEVB

## Electromagnetic Compatibility – Conducted Emissions EN55015 Limits

Measured conditions:

- Output power  $P_{out} \sim 18 \Omega$  resistive load
- Input voltage  $\sim 250 \text{ V}$

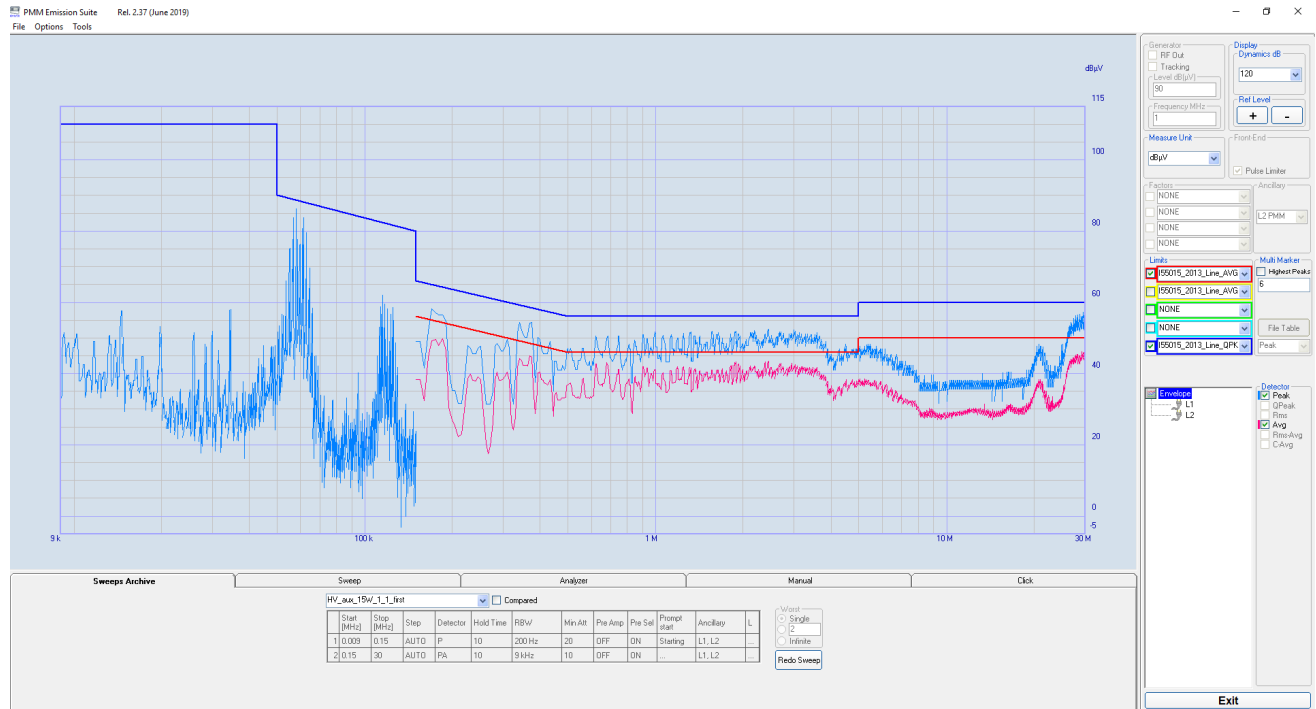

Figure 20.

# SECO-HVDCDC1362-15W-GEVB

## Transformer Design

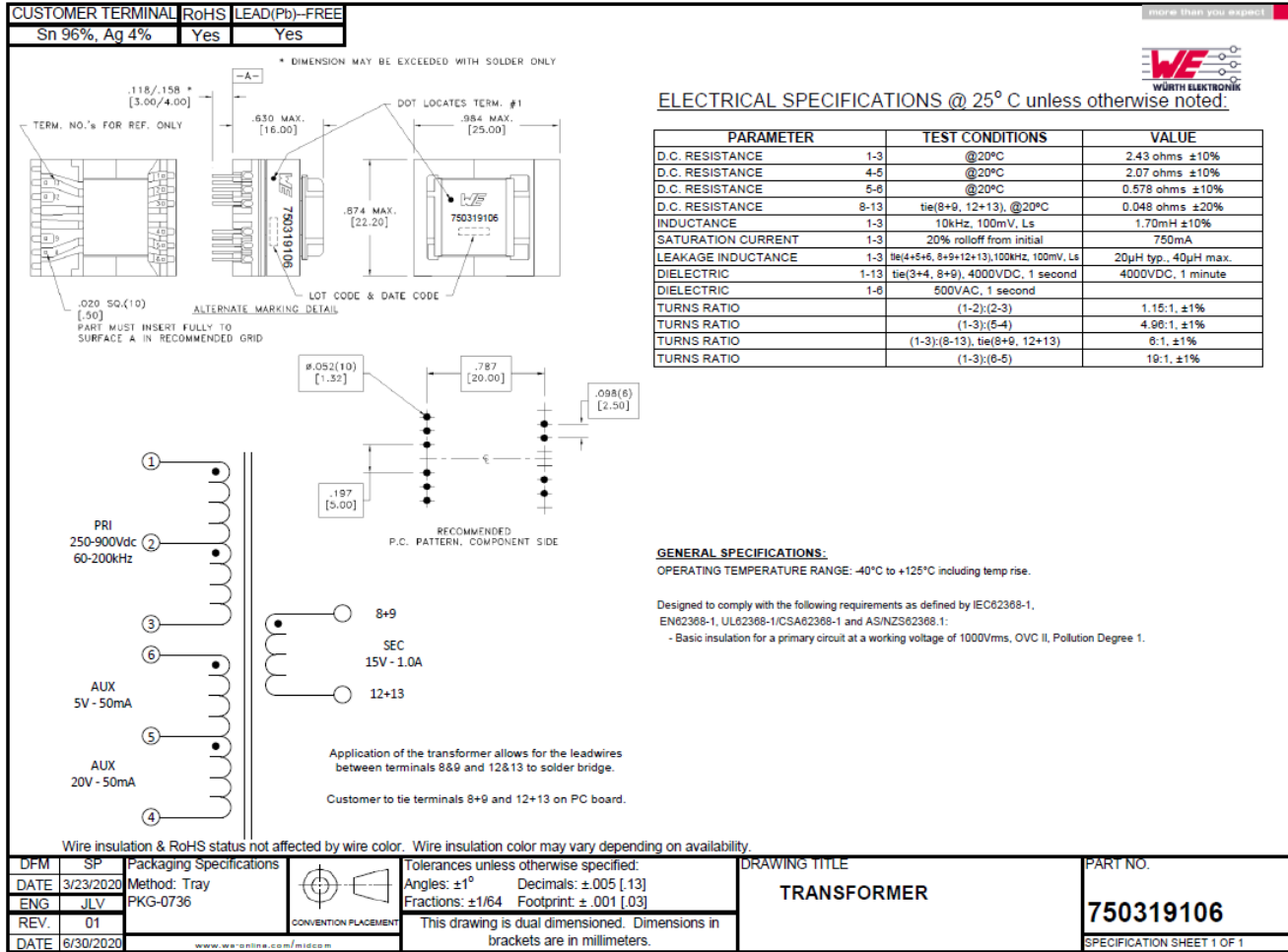

Figure 21. Drawing and Parameters of Used Transformer

## SECO-HVDCDC1362-15W-GEVB

### Development Resources and Tools

Collateral, development files and other development resources listed below are available at [SECO-HVDCDC1362-15W-GEVB](http://www.onsemi.com/SECO-HVDCDC1362-15W-GEVB)

- Schematics
- BOM (below as well)
- Manufacturing files
- PCB layout (below as well)
- Altium files
- Simulation model (below as well)

**Table 1. BILL OF MATERIAL**

Des.	Comment	Description	Manufacturer	Manufacturer Part Number
C2	470pF	MLC capacitor 470pF 1kV ±10% X7R Würth Elektronik	Würth Elektronik	885342208017
C3, C4	100 nF	MMKT film capacitor 100n 500Vac/1600Vdc TDK	TDK	B32643B1104J000
C5	100 nF	Multilayer Ceramic Capacitors MLCC – SMD 1206 25 V 100 nF C0G ± 1 % AEC-Q202 –55 – 125 °C	Murata	GRT31C5C1E104FA02
C6	1000 µF	ALU electrolyte high current ripple 1000 µF 25 V 20% Nichicon	NICHICON	UBT1E102MHD1TO
C7	470 nF	Multilayer Ceramic Capacitors MLCC – SMD 0805 50 V 470 nF X7R ± 10 % AEC-Q202 –55 – 125 °C	Murata	GRT21BR71H474KE01
C8	4.7 µF	Multilayer Ceramic Capacitors MLCC – SMD 1210 50 V 4.7 µF X7R ± 10 % AEC-Q202 –55 – 125 °C	Murata	GRT32ER71H475KE01
C9	100 nF	Multilayer Ceramic Capacitors MLCC – SMD 1206 50 V 100 nF C0G ± 5 % AEC-Q202 –55 – 125 °C	Murata	GRT31C5C1H104JA02
C10, C15	120 pF	Multilayer Ceramic Capacitors MLCC – SMD 0603 100 V 120 pF C0G ± 5 % AEC-Q202 –55 – 125 °C	Murata	GRT1885C2A121JA02
C12	150 nF	Multilayer Ceramic Capacitors MLCC – SMD 0603 25 V 150 nF X7R ± 10 % AEC-Q202 –55 – 125 °C	Murata	GRT188R71E154KE01
C13	1n8	Multilayer Ceramic Capacitors MLCC – SMD 0805 100 V 1n8 C0G ± 5 % AEC-Q202 –55 – 125 °C	Murata	GRT2165C2A182JA02
C14	3n3	Multilayer Ceramic Capacitors MLCC – SMD 0805 100 V 3n3 C0G ± 5 % AEC-Q202 –55 – 125 °C	Murata	GRT2165C2A332JA02
C17	4.7 pF	Multilayer Ceramic Capacitors MLCC – SMD 0603 100 V 4.7 pF C0G ± 5 % AEC-Q200 –55 – 125 °C	Murata	GCM1885C2A4R7CA16D
CON1	RED	Banana Test Connector, 4mm, Receptacle, PCB Mount, 24 A, 1 kV, Gold Plated Contacts, Red	CLIFF Electronic Components	FCR7350R
CON2	691 313 510 002	PCB right angle connector 2 pins 5.08 mm pitch Würth Elektronik	Würth Elektronik	691313510002
CON3	BLACK	Banana Test Connector, 4mm, Receptacle, PCB Mount, 24 A, 1 kV, Gold Plated Contacts, Black	CLIFF Electronic Components	FCR7350B
CON4	613 008 243 121	WR-PHD 2.54 mm Angled Dual Socket Header 2x4 pins	Würth Elektronik	613008243121
CON5	691 351 500 002	Cable connector series 351 2pins 5.08 mm Würth Elektronik	Würth Elektronik	691351500002
CY1	2n2	Disc ceramic capacitor 2n2 1500 VDC Y5U 10 % Vishay AEC-Q200	VISHAY	AY1222M47Y5UC63L0
D1	FFSD0665B -F085	Ultra fast Schottky SiC diode 650V 6A AEC-Q101 ON Semiconductor	ON Semiconductor	FFSD0665B-F085
D2	TPSMB210A	TVS 210V 600W SMB unidirectional Littelfuse AEC-Q101	Littelfuse	TPSMB210A
D3	SZ1SMA593 1BT3G	TVS zener diode 18 V 83 mA SMA AEC-Q101 ON Semiconductor	ON Semiconductor	SZ1SMA5931BT3G
D4	NRVUS1MFA	Super Fast diode 1000 V 1 A 75 ns SOD123FA AEC-Q101, ON Semiconductor	ON Semiconductor	NRVUS1MFA
D5	NSVBAS21A HT1G	Switching diode 250V 200mA SOD323 AEC-Q101 ON Semiconductor	ON Semiconductor	NSVBAS21AHT1G
D6	SZMMSZ18 T1G	Zener Single Diode, 18 V, 500 mW, SOD-123, 5 %, 2 Pins, 150 µC, AEC-Q101	ON Semiconductor	SZMMSZ18T1G

## SECO-HVDCDC1362-15W-GEVB

**Table 1. BILL OF MATERIAL** (continued)

Des.	Comment	Description	Manufacturer	Manufacturer Part Number
D7	NRVBA130L T3G	Schottky diode 30 V 1 A SMA ON Semiconductor	ON Semiconductor	NRVBA130LT3G
D8	SZMMSZ20 T1G	Zener Diodes 20V 500mW SOD123 AEC-Q101 ON Semiconductor	ON Semiconductor	SZMMSZ20T1G
IC1	NCV1362BA	Automotive Primary Side Flyback Controller	ON Semiconductor	NCV1362BADR2G
L1	4.7 mH	Fixed Inductors RFB 1010 Lead Rad 4.7mH 0.28A 9.6 Ω	Coilcraft	RFB1010-472L
Q1	NSVBC817-40W	General purpose NPN transistor 45V 500mA ON Semiconductor	ON Semiconductor	NSVBC817-40WT1G
Q3	NVHL160N1 20SC1	SiC NMOS 1200V 17A 160mΩ ON Semiconductor	ON Semiconductor	NVHL160N120SC1
R3	6M8	High Ohmic / High Voltage Metal Glaze Leaded Resistors 0207 6M8 5% 250mW Vishay	Vishay	VR25000006804JA500
R4	10M	High Ohmic / High Voltage Metal Glaze Leaded Resistors 0207 10M 5% 250mW Vishay	Vishay	VR25000001005JA100
R5, R6, R9	100k	SMD Chip Resistor, 100 kΩ, MCWR Series, 200 V, Thick Film, 1206 [3216 Metric], 250 mW Multicomp	Multicomp	MCWR12X1003FTL
R10, R19	0R	SMD Chip Resistor, 0 Ω, ERJ8G Series, 200 V, Thick Film, 1206 [3216 Metric], 250 mW Panasonic	Panasonic	ERJ8GEY0R00V
R13	4k7	SMD thick film resistor 4k7 0603 1% 100 mW Panasonic	Panasonic	ERA3AED4701V
R17	154k	SMD thick film resistor 154k 0805 1% 125 mW Panasonic	Panasonic	ERA6AED1543V
R24	270k	SMD thick film resistor 270k 0603 1% 100 mW Panasonic	Panasonic	ERA3AED2703V
R25	10k	SMD thick film resistor 10k 0805 1% 125 mW Panasonic	Panasonic	ERA6AED1002V
R26	8R2	SMD thick film resistor 8 Ω 1206 1% 500 mW Panasonic	Panasonic	ERJ8BQF8R2V
R28	1k	SMD thick film resistor 1k 1206 1% 250 mW Panasonic	Panasonic	ERA8AED1001V
R29	100k	SMD Thermistor, 100 kΩ, NTCG-S Series, 0805 [2012 Metric], 200 mW TDK	TDK	NTCG204CH104JT1
R30	34k8	SMD thick film resistor 34k8 0603 1% 100 mW Panasonic	Panasonic	ERA3AED3482V
R31	1R8	SMD current sense resistor 1R8 1206 1% 330 mW Panasonic	Panasonic	ERJ8BQF1R8V
R32	1R2	SMD thick film resistor 1.2 Ω 1206 1% 500 mW Panasonic	Panasonic	ERJ8BQF1R2V
R33	51k1	SMD thick film resistor 51k1 0603 1% 100 mW Panasonic	Panasonic	ERA3AED5112V
R34	46k4	SMD thick film resistor 46k4 0603 1% 100 mW Panasonic	Panasonic	ERA3AED4642V
SB1, SB2, SB3, SB4	Plastic spacer M3 M/F 8/5 HEX6	Plastic spacer internal/external M3x8 thread, 5 mm Würth Elektronik	Würth Elektronik	971050365
ST1, ST2, ST3, ST4	Plastic spacer M3 F/F 10/25 HEX6	Plastic spacer internal/internal M3x6 thread, 25 mm Würth Elektronik	Würth Elektronik	970250365
T1	750319106	Transformer for DC-DC (NCV1362 flyback 250V-900VDC@15W) converter from Würth Elektronik	Würth Elektronik	TR_WE_750319106
TP1	ORANGE	PTH testpoint eyelet 3.2 mm orange Keystone Electronics	Keystone Electronics	5008



# SECO-HVDCDC1362-15W-GEVB

**Table 1. BILL OF MATERIAL** (continued)

Des.	Comment	Description	Manufacturer	Manufacturer Part Number
TP2, TP3	RED	PTH testpoint eyelet 3.2 mm red Keystone Electronics	Keystone Electronics	5005
TP4	BROWN	PTH testpoint eyelet 3.2 mm brown Keystone Electronics	Keystone Electronics	5120
TP5	BLUE	PTH testpoint eyelet 3.2 mm blue Keystone Electronics	Keystone Electronics	5122
TP6	BLACK	PTH testpoint eyelet 3.2 mm black Keystone Electronics	Keystone Electronics	5006

## Layout

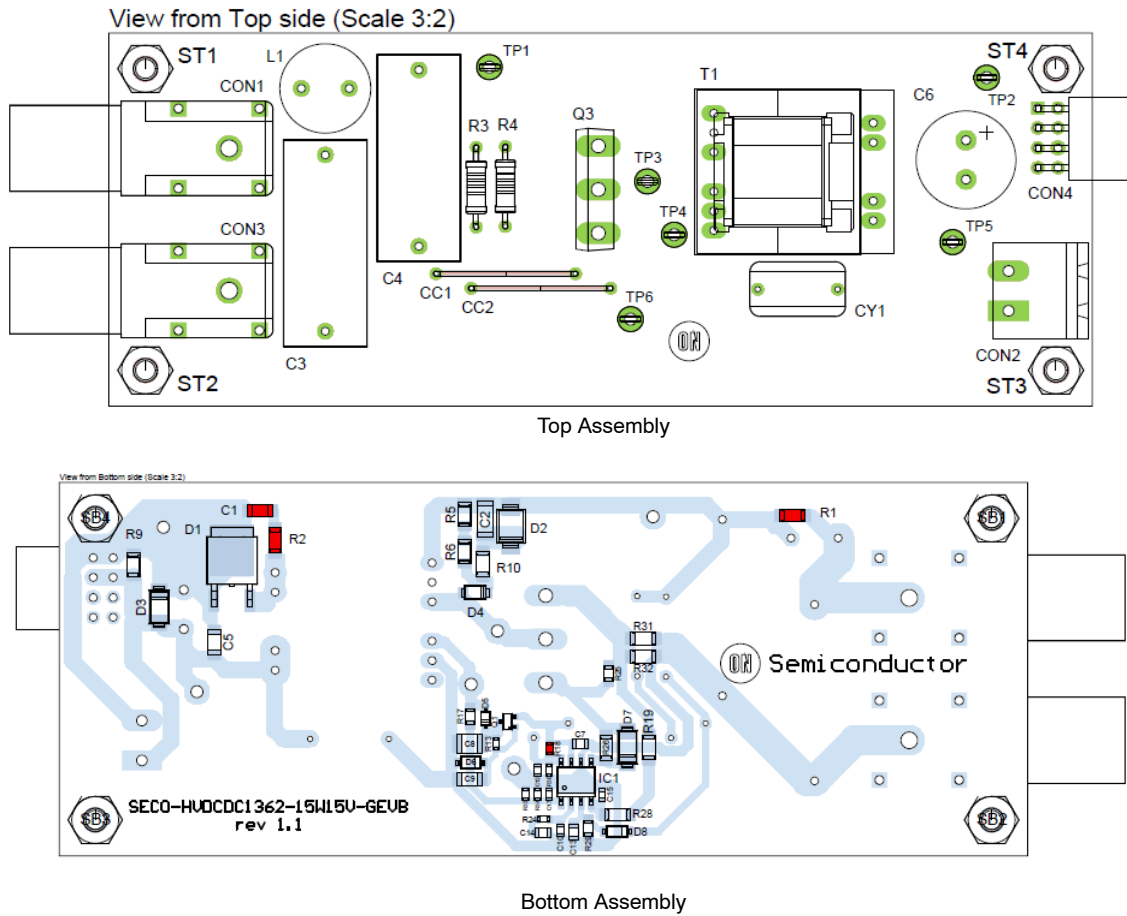

**Figure 22. Layout**

## References

- NCV1362 Data sheet
- NCV1362 Application notes
- NCV1362 [Evaluation boards](#)
- NCV1362 Design worksheet MathCad

**onsemi**, **Onsemi**, and other names, marks, and brands are registered and/or common law trademarks of Semiconductor Components Industries, LLC dba "**onsemi**" or its affiliates and/or subsidiaries in the United States and/or other countries. **onsemi** owns the rights to a number of patents, trademarks, copyrights, trade secrets, and other intellectual property. A listing of **onsemi**'s product/patent coverage may be accessed at [www.onsemi.com/site/pdf/Patent-Marking.pdf](http://www.onsemi.com/site/pdf/Patent-Marking.pdf). **onsemi** is an Equal Opportunity/Affirmative Action Employer. This literature is subject to all applicable copyright laws and is not for resale in any manner.

The evaluation board/kit (research and development board/kit) (hereinafter the "board") is not a finished product and is not available for sale to consumers. The board is only intended for research, development, demonstration and evaluation purposes and will only be used in laboratory/development areas by persons with an engineering/technical training and familiar with the risks associated with handling electrical/mechanical components, systems and subsystems. This person assumes full responsibility/liability for proper and safe handling. Any other use, resale or redistribution for any other purpose is strictly prohibited.

**THE BOARD IS PROVIDED BY ONSEMI TO YOU "AS IS" AND WITHOUT ANY REPRESENTATIONS OR WARRANTIES WHATSOEVER. WITHOUT LIMITING THE FOREGOING, ONSEMI (AND ITS LICENSORS/SUPPLIERS) HEREBY DISCLAIMS ANY AND ALL REPRESENTATIONS AND WARRANTIES IN RELATION TO THE BOARD, ANY MODIFICATIONS, OR THIS AGREEMENT, WHETHER EXPRESS, IMPLIED, STATUTORY OR OTHERWISE, INCLUDING WITHOUT LIMITATION ANY AND ALL REPRESENTATIONS AND WARRANTIES OF MERCHANTABILITY, FITNESS FOR A PARTICULAR PURPOSE, TITLE, NON-INFRINGEMENT, AND THOSE ARISING FROM A COURSE OF DEALING, TRADE USAGE, TRADE CUSTOM OR TRADE PRACTICE.**

**onsemi** reserves the right to make changes without further notice to any board.

You are responsible for determining whether the board will be suitable for your intended use or application or will achieve your intended results. Prior to using or distributing any systems that have been evaluated, designed or tested using the board, you agree to test and validate your design to confirm the functionality for your application. Any technical, applications or design information or advice, quality characterization, reliability data or other services provided by **onsemi** shall not constitute any representation or warranty by **onsemi**, and no additional obligations or liabilities shall arise from **onsemi** having provided such information or services.

**onsemi** products including the boards are not designed, intended, or authorized for use in life support systems, or any FDA Class 3 medical devices or medical devices with a similar or equivalent classification in a foreign jurisdiction, or any devices intended for implantation in the human body. You agree to indemnify, defend and hold harmless **onsemi**, its directors, officers, employees, representatives, agents, subsidiaries, affiliates, distributors, and assigns, against any and all liabilities, losses, costs, damages, judgments, and expenses, arising out of any claim, demand, investigation, lawsuit, regulatory action or cause of action arising out of or associated with any unauthorized use, even if such claim alleges that **onsemi** was negligent regarding the design or manufacture of any products and/or the board.

This evaluation board/kit does not fall within the scope of the European Union directives regarding electromagnetic compatibility, restricted substances (RoHS), recycling (WEEE), FCC, CE or UL, and may not meet the technical requirements of these or other related directives.

FCC WARNING – This evaluation board/kit is intended for use for engineering development, demonstration, or evaluation purposes only and is not considered by **onsemi** to be a finished end product fit for general consumer use. It may generate, use, or radiate radio frequency energy and has not been tested for compliance with the limits of computing devices pursuant to part 15 of FCC rules, which are designed to provide reasonable protection against radio frequency interference. Operation of this equipment may cause interference with radio communications, in which case the user shall be responsible, at its expense, to take whatever measures may be required to correct this interference.

**onsemi** does not convey any license under its patent rights nor the rights of others.

LIMITATIONS OF LIABILITY: **onsemi** shall not be liable for any special, consequential, incidental, indirect or punitive damages, including, but not limited to the costs of requalification, delay, loss of profits or goodwill, arising out of or in connection with the board, even if **onsemi** is advised of the possibility of such damages. In no event shall **onsemi**'s aggregate liability from any obligation arising out of or in connection with the board, under any theory of liability, exceed the purchase price paid for the board, if any.

The board is provided to you subject to the license and other terms per **onsemi**'s standard terms and conditions of sale. For more information and documentation, please visit [www.onsemi.com](http://www.onsemi.com).

## ADDITIONAL INFORMATION

### TECHNICAL PUBLICATIONS:

Technical Library: [www.onsemi.com/design/resources/technical-documentation](http://www.onsemi.com/design/resources/technical-documentation)  
onsemi Website: [www.onsemi.com](http://www.onsemi.com)

ONLINE SUPPORT: [www.onsemi.com/support](http://www.onsemi.com/support)

For additional information, please contact your local Sales Representative at [www.onsemi.com/support/sales](http://www.onsemi.com/support/sales)