

40 W SiC High-Voltage Auxiliary Power Supply for HEV & BEV Applications Evaluation Board User's Manual



ON Semiconductor®

www.onsemi.com

SECO-HVDCDC1362-40W-GEVB

EVAL BOARD USER'S MANUAL

Introduction

SECO-HVDCDC1362-40W-GEVB is highly efficient and primary-side regulated (PSR) auxiliary power supply targeting HEV and EV automotive power trains. The design provides a stable 15 V output and 40 W over a wide input DC voltage range from 250 V to 900 V, and is therefore suitable for 400 V and 800 V battery systems.

The board employs the NCV1362 quasi-resonant peak current PSR flyback controller, the 3-lead cost-optimized NVHL160N120SC1 160 m Ω 1200 V silicon carbide (SiC) MOSFET, and the FFSP0665B-F085 SiC diode.

Thanks to the high blocking voltage capabilities and ultra-low gate charge (34 nC) value of the SiC FET, the switching losses are significantly reduced, and the board exhibits a superior efficiency for the application up to 86% in low line input conditions. The notable driving capabilities of the NCV1362 controller allows for direct operation of the SiC FET at 12 V without a pre-driver, simplifying the layout and cutting down the component count.

The flyback transformer provides 4 kV isolation and is optimized to minimize the losses on the RCD snubber. Consequently the system effectively dampens the drain voltage overshoot at high line, and provides 100 V margin for the SiC FET. The board is fully realized with automotive qualified semiconductors and passive devices. Industrial grade replacements are also available.

Features

- NCV1362 (Automotive) / NCP1362 (Industrial) Quasi-resonant Peak Current PSR Flyback Controller
- Fully Automotive Qualified Devices
- V_{in} = 240 V – 900 V DC Only
- V_{out} = 15 V / 40 W Continuous
- Electromagnetic Compatibility (EN 55015 Limits)
- High Efficiency up to 85.5%
- SiC FET Directly Operated at 12 V by the IC
- Excellent Thermal Performance

Applications

- HEV & EV Vehicles Auxiliary Power Supplies
- Automotive Powertrain Systems
- EV Charging and DC-DC Conversion
- Industrial DC-DC Conversion, Solar Inverts (with Industrial Grade)



(Top View)



(Bottom View)

Figure 1. Board Layout

Benefits

- Superior Efficiency with SiC Devices
- Stable Performance across a Wide Input Voltage Range (250 Vdc – 900 Vdc)
- Reduced Bill-of-Material and Cost-optimized
- Fully AEC-Q Qualified Parts
- EMC within EN 55015 Limits
- Single Layer PCB

Collateral

- [NVHL160N120SC1](#)
- [NCV1362](#)
- [SECO-HVDCDC1362-40W-GEVB](#)
- [References](#)

SECO-HVDCDC1362-40W-GEVB

Scope and Purpose

The purpose of this user's manual is to present the design of an auxiliary power supply with automotive qualified parts NCV1362 (NCP1362) and NVHL160N120SC1 SiC FET. The design was tested as described in this document but not

qualified regarding safety requirements or manufacturing and operation over the complete operating temperature range or lifetime. The hardware is intended for testing under laboratory conditions and by trained specialists only.

System Overview

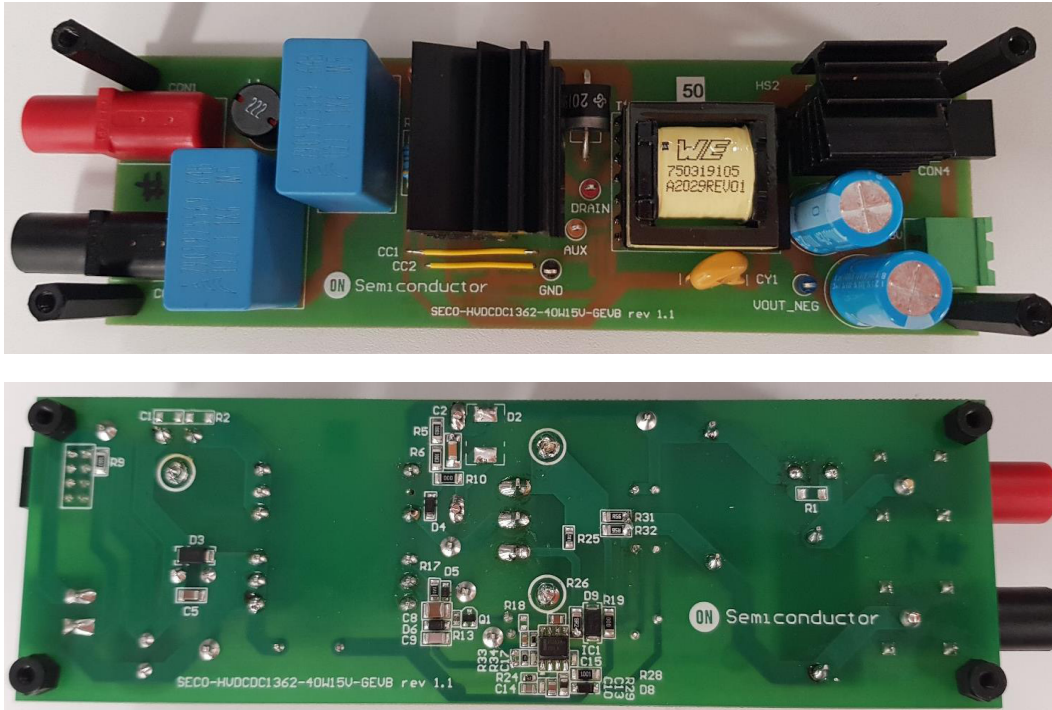

Figure 2. Evaluation Board Photo

Block Diagram

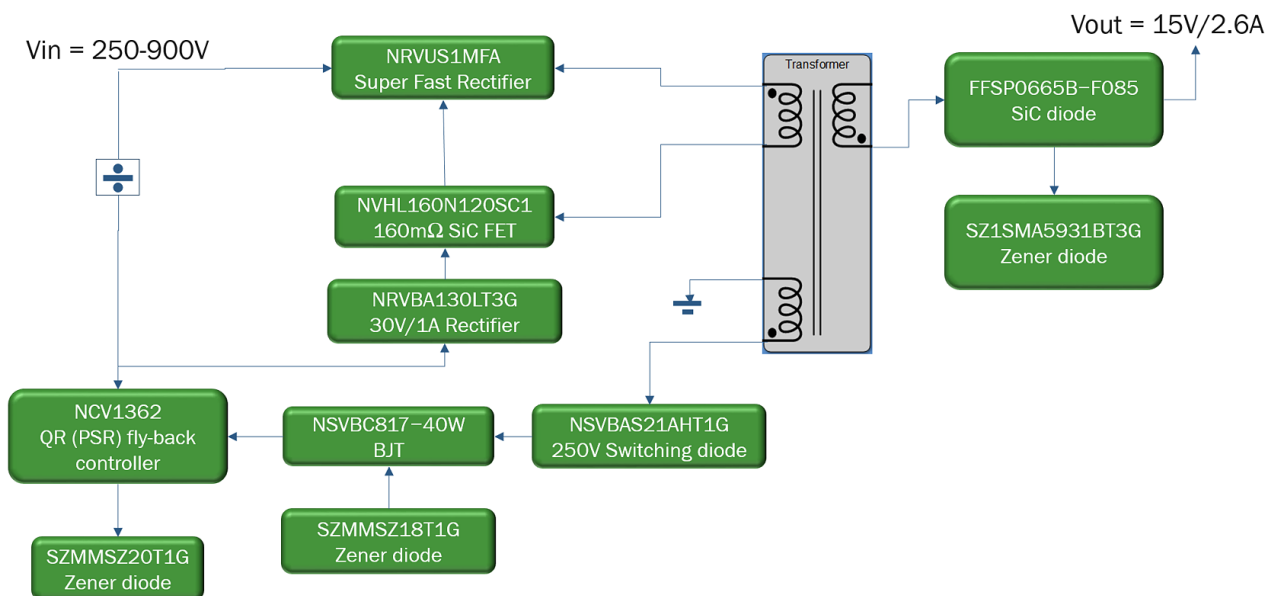

Figure 3. Block Diagram

SECO-HVDCDC1362-40W-GEVB

SPECIFICATION

Parameters	Values
Input	
Voltage	250-900 VDC
Current	191 mA ($V_{in} = 250$ V), 56 mA ($V_{in} = 900$ V)
Output	
Power	40 W
Voltage	15 VDC
Current per branch	2.66 A
Total current	2.66 A
Efficiency at full load	85.5% ($V_{in} = 250$ V)
Temperature at full load	98°C ($V_{in} = 6$ V), 74.5°C ($V_{in} = 15$ V), 76°C ($V_{in} = 18$ V)
Control	
Core part	NCV1362
Topology	Flyback
Switching frequency	50 kHz
Operation mode	DCM
Primary side peak current	1.5 A
Construction	
Board size	52.2 x 164.2 x 40 mm
Transformer	
Dielectric insulation	4000 VAC, 1 min.
Inductance	0.95 mH \pm 10%
Leakage inductance	20 μ H typ. / 40 μ H max.
Safety standard	IEC62368-1
Pollution degree	1
Application	
HEV & EV vehicles, automotive powertrain systems, EV charging and DC-DC conversion	

SECO-HVDCDC1362-40W-GEVB

Schematic

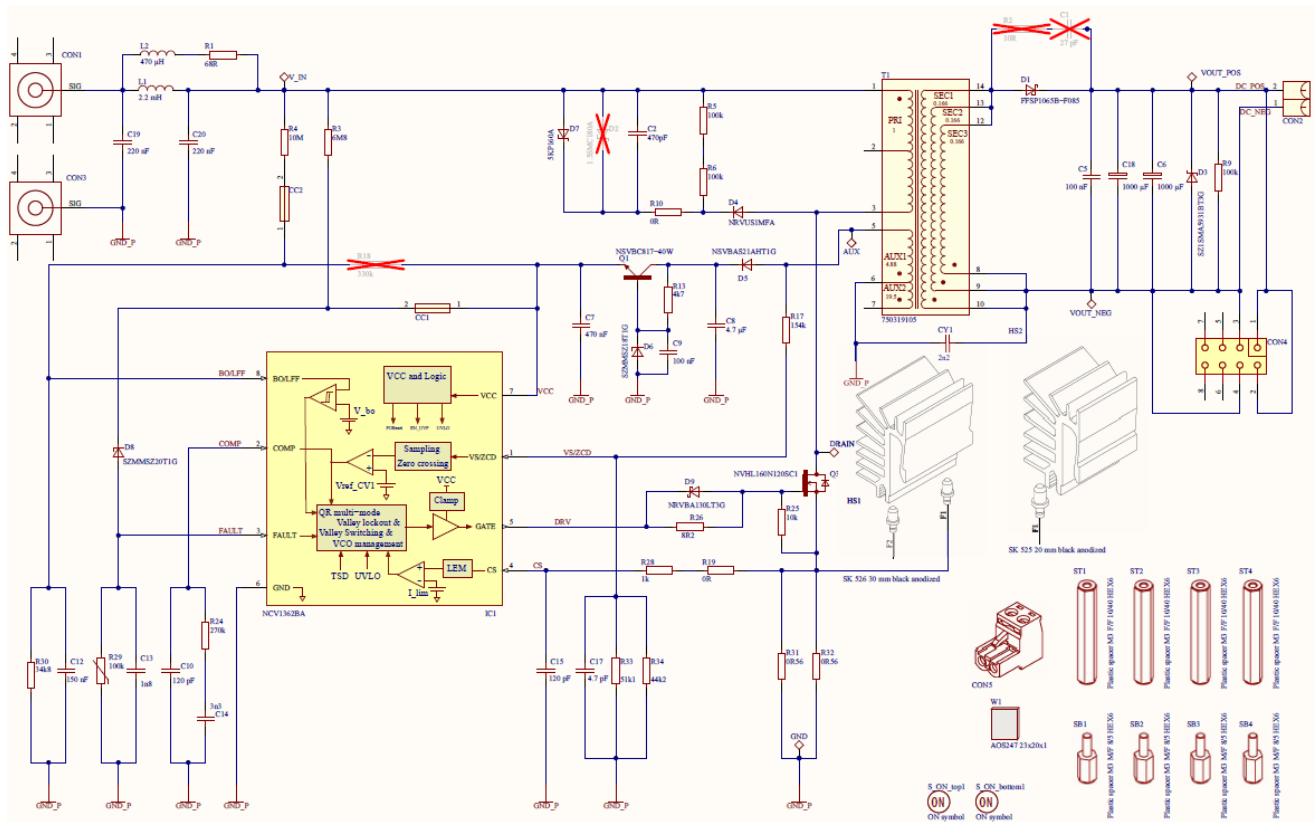

Figure 4. Evaluation Board Schematic

TEST REPORT

This section presents the results of the tests conducted on the power supply.

- Efficiency DC/DC at input voltage range and full load
- Waveforms at 240 V, 500 V, 900 V at full load / open circuit
- Load transients 15%–85% and 15%–85% load
- Thermal camera view
- Electromagnetic compatibility

Efficiency DC/DC at Input Voltage Range and Full Load

Measured conditions:

- Output power $P_{out} \sim 40\text{ W}$
- Electronic load: Chroma 6147A used channel 3 as CRH (constant resistance high mode $5.5\ \Omega \rightarrow 2.66\ \text{A}$)

List of equipment:

- DC source: Magna-Power 0–1000V
- Power analyzer: Textronix PA3000
- Electronic load: Chroma

Efficiency 40W HV Auxiliary

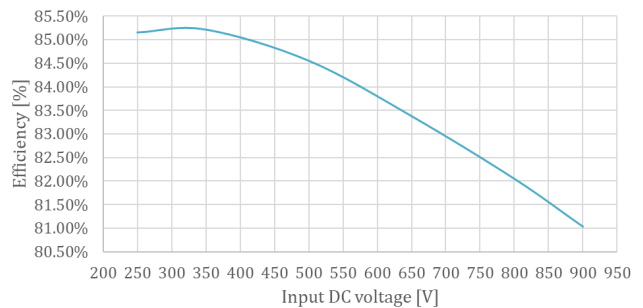

Power losses 40W HV Auxiliary

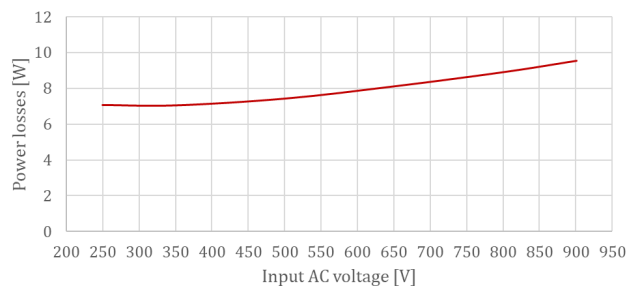

Figure 5.

SECO-HVDCDC1362-40W-GEVB

Waveforms at 240 V, 500 V, 900 V at Full Load / Open Circuit

Measured conditions:

- Output power $P_{out} \sim 40$ W
- Electronic load: Chroma 6147A used channel 3 as CRH (constant resistance high mode $5.5 \Omega \rightarrow 2.66 \text{ A}$)

List of equipment:

- DC source: Magna-Power 0-1000V
- Power analyzer: Textronix PA3000
- Electronic load: Chroma
- Oscilloscope: Lecroy HDO8038

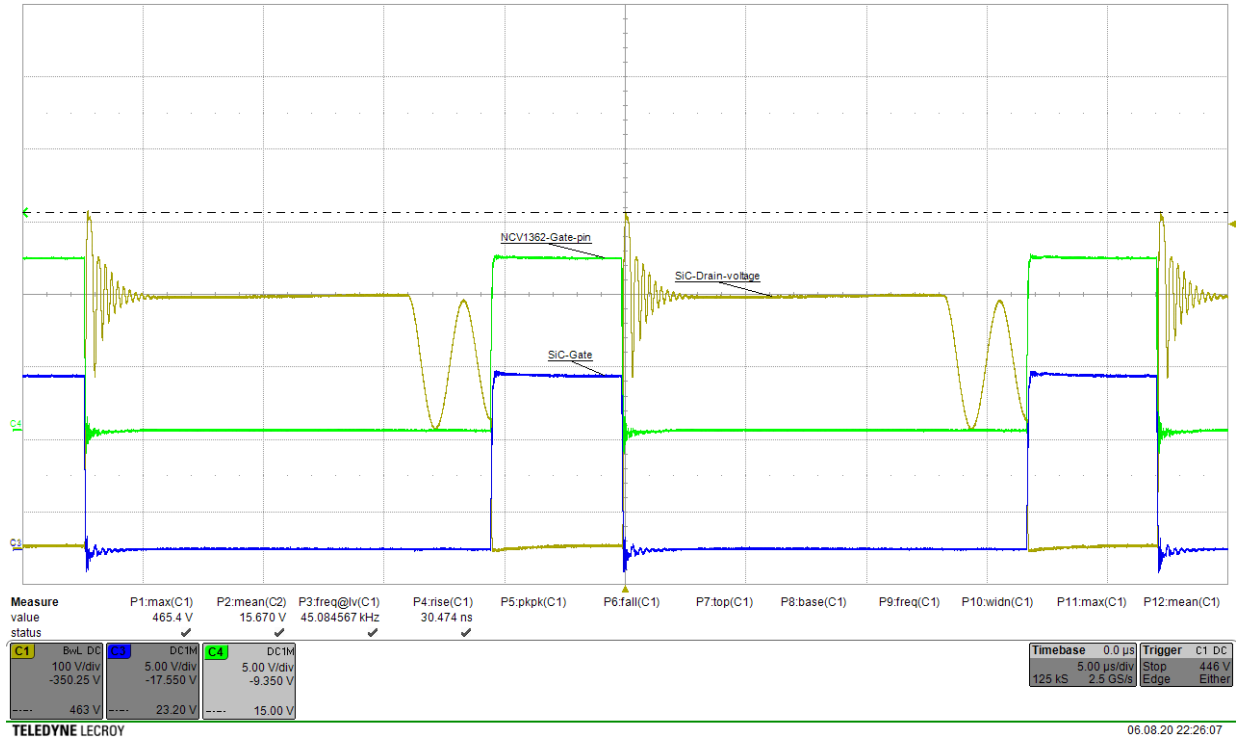

Figure 6. 250 V DC Full Load

06.08.20 22:26:07

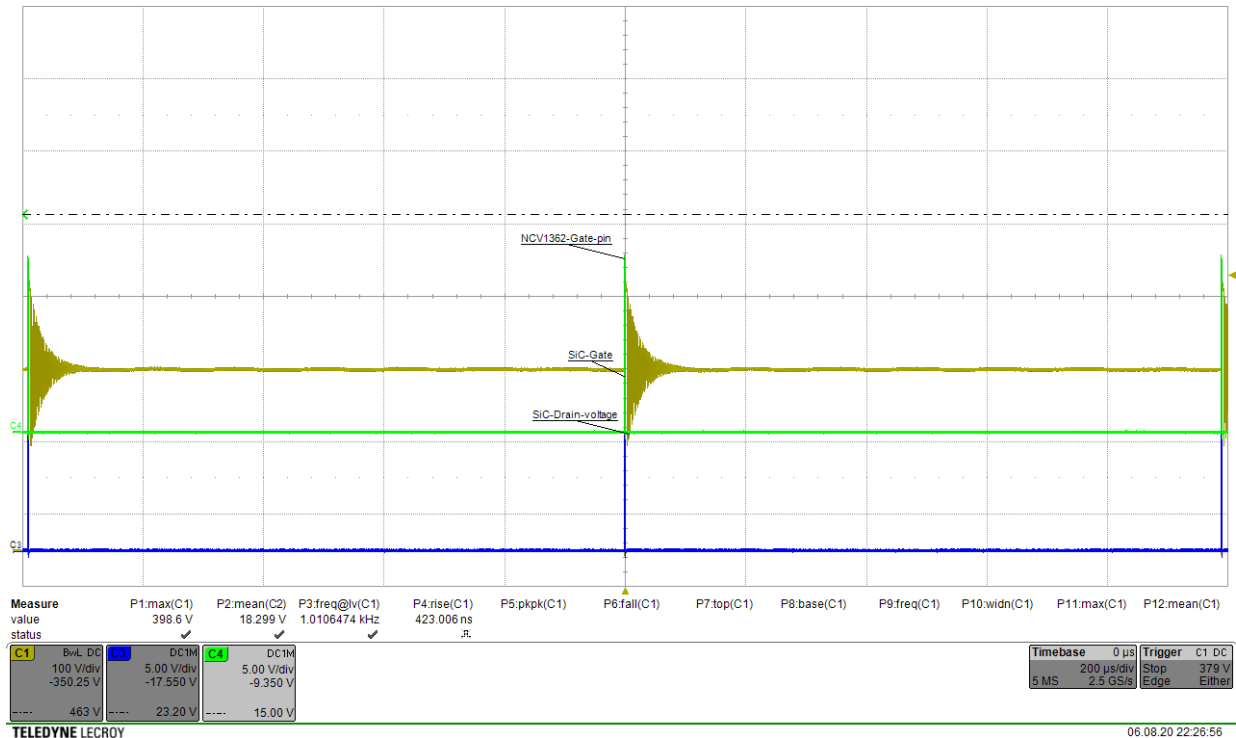

Figure 7. 250 V DC Open Circuit

06.08.20 22:26:56

SECO-HVDCDC1362-40W-GEVB

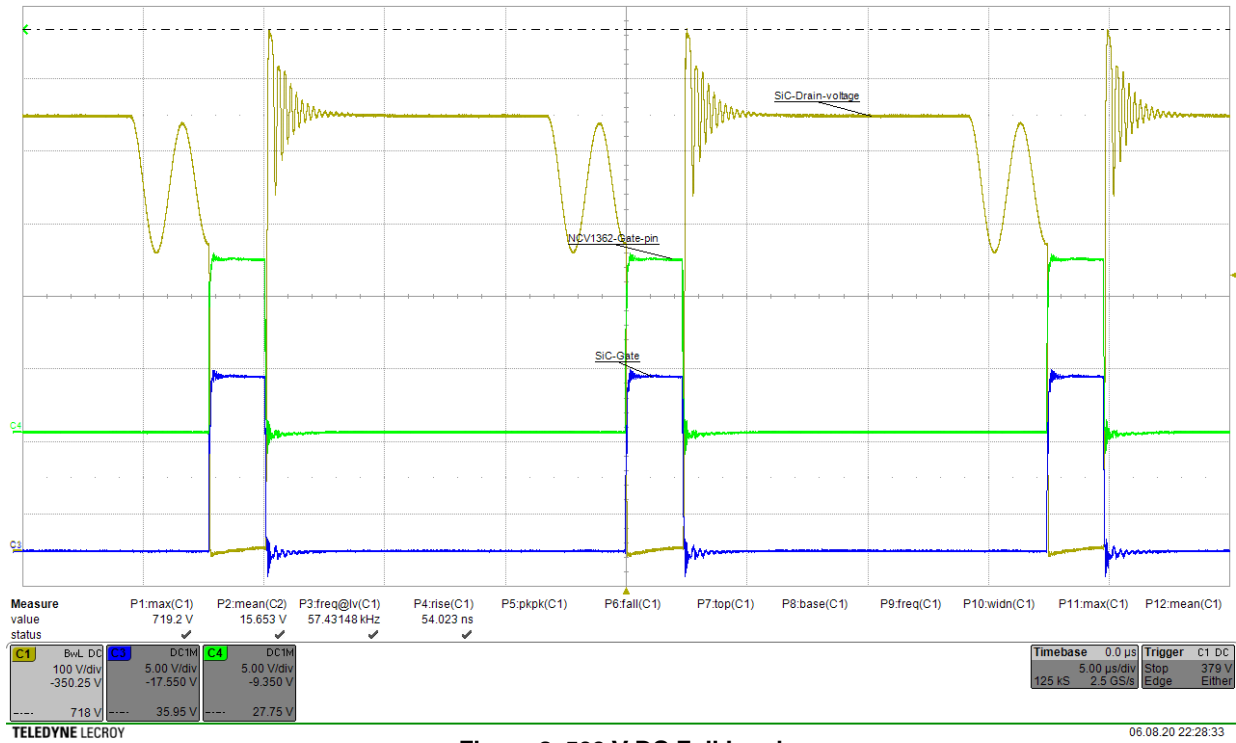

Figure 8. 500 V DC Full Load

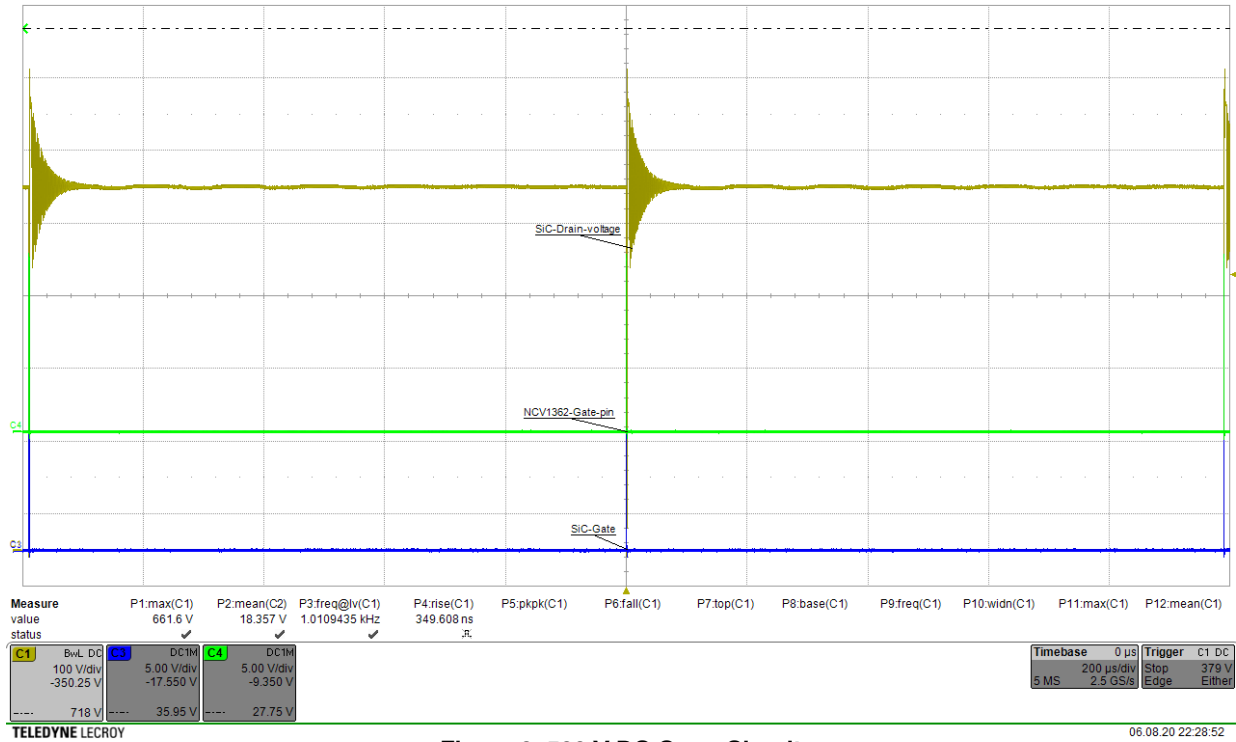

Figure 9. 500 V DC Open Circuit

SECO-HVDCDC1362-40W-GEVB

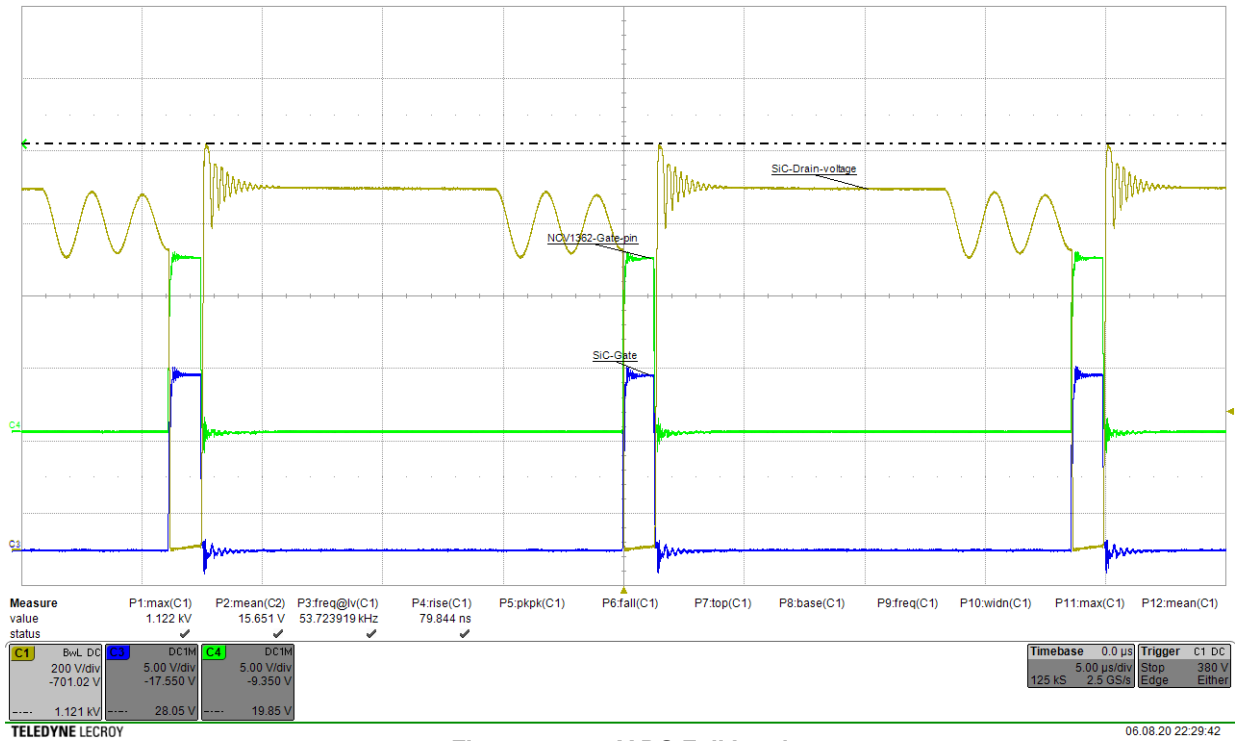

Figure 10. 900 V DC Full Load

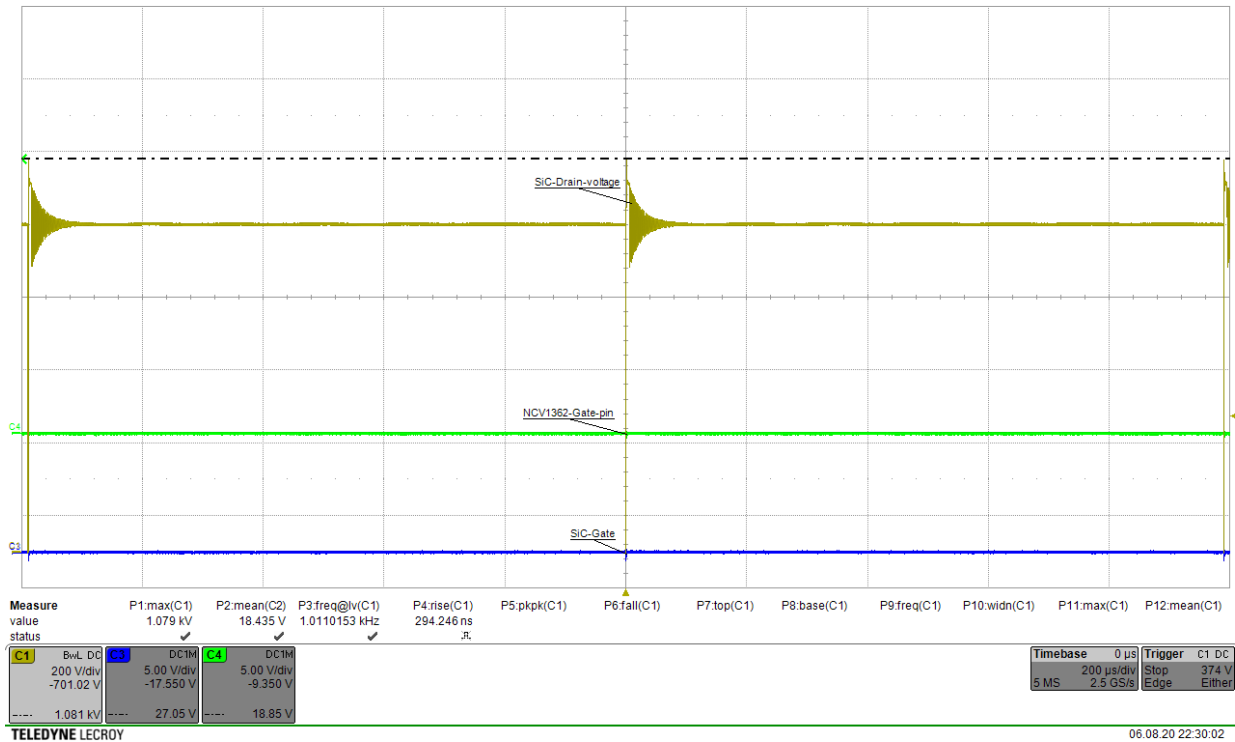

Figure 11. 900 V DC Open Circuit

SECO-HVDCDC1362-40W-GEVB

Load Transients 15%–85% and 15%–85% Load

Measured conditions:

- Output power $P_{out} \sim 40\text{ W}$
- Electronic load: Chroma 6147A used channel 3 as CCDH (constant current dynamic mode $0.39\text{ A} \rightarrow 2.26\text{ A}$)

List of equipment:

- DC source: Magna-Power 0–1000V
- Power analyzer: Textronix PA3000
- Electronic load: Chroma
- Oscilloscope: Lecroy HDO8038

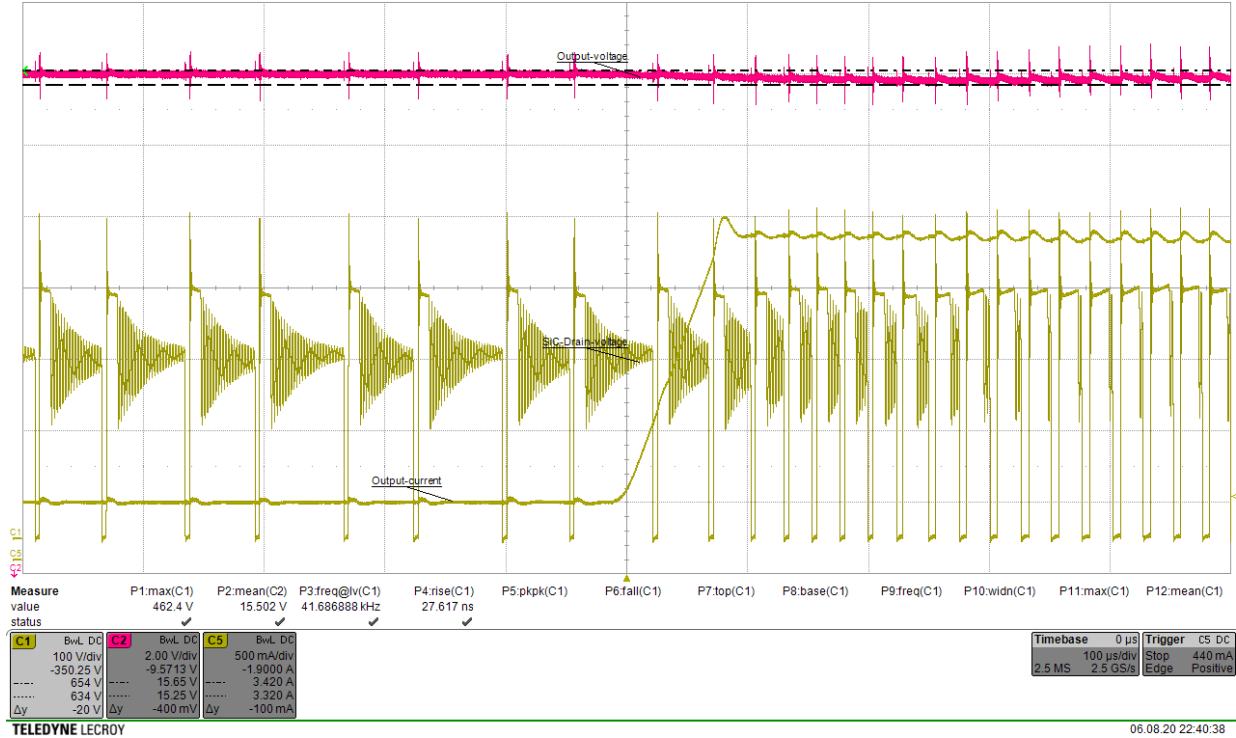

Figure 12. 250 V – 15% to 85%

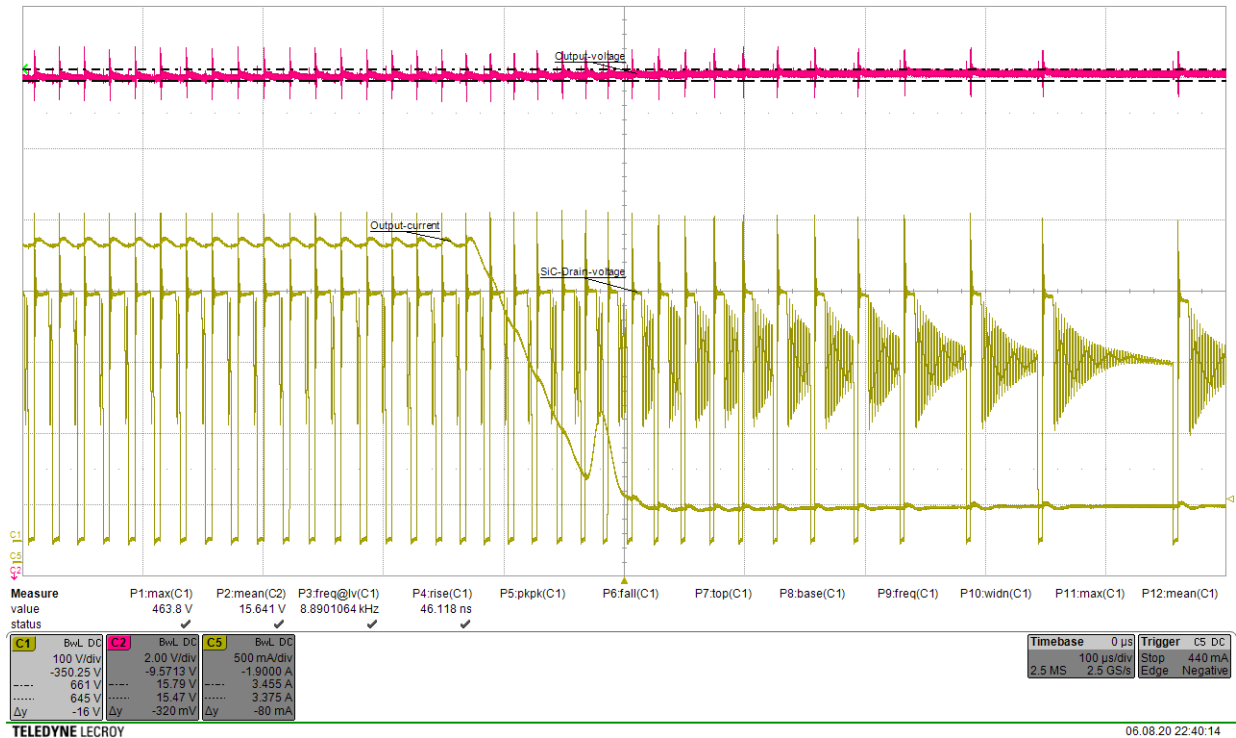

Figure 13. 250 V – 85% to 15%

SECO-HVDCDC1362-40W-GEVB

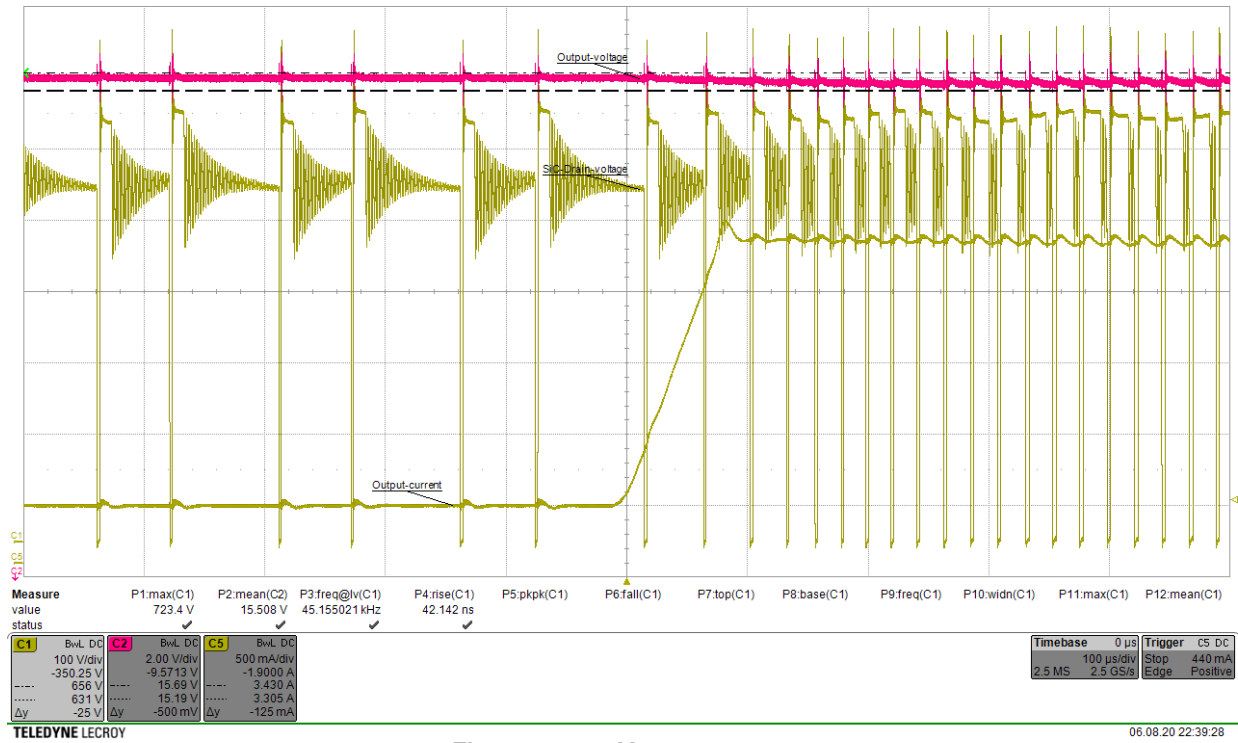

Figure 14. 500 V – 15% to 85%

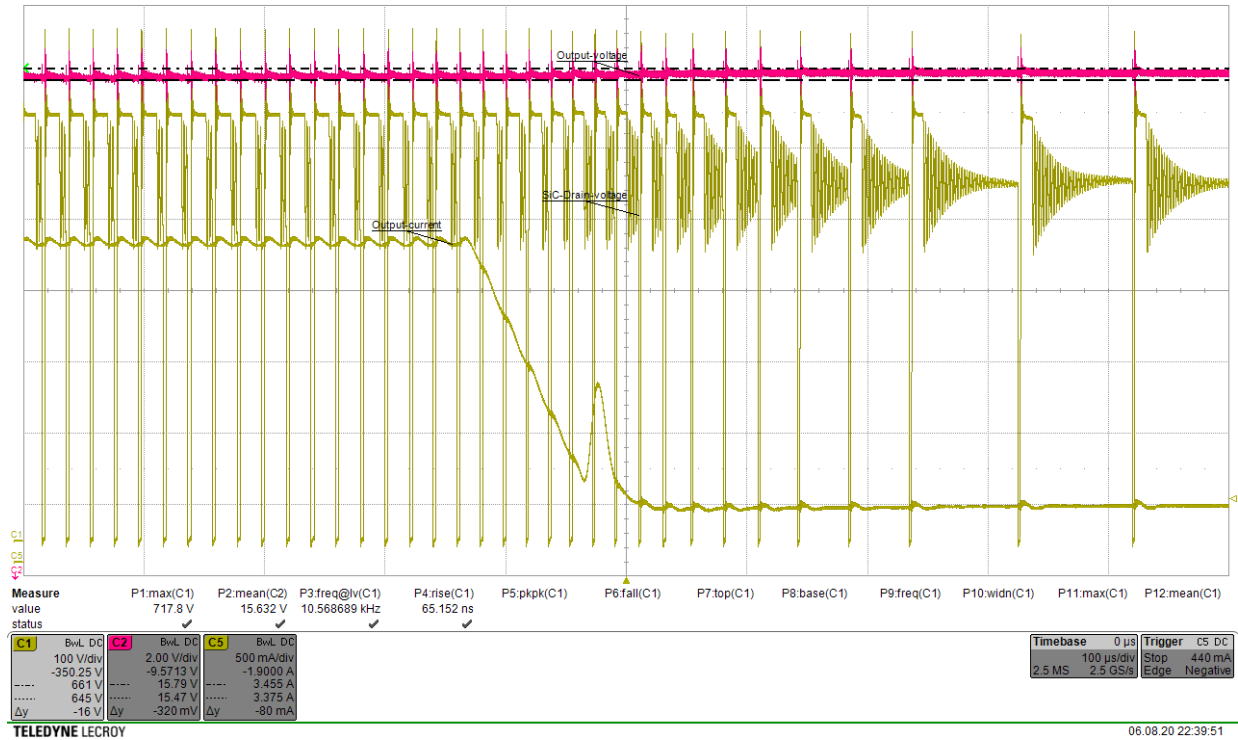

Figure 15. 500 V – 85% to 15%

SECO-HVDCDC1362-40W-GEVB

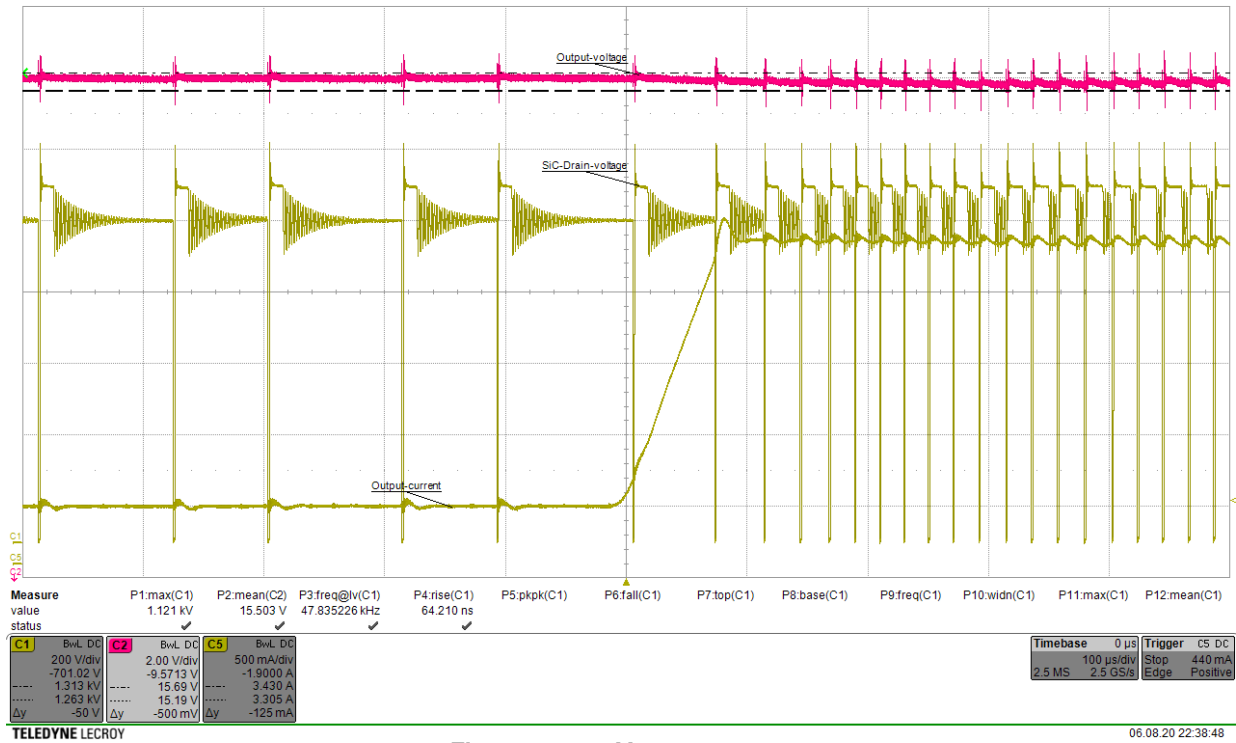

Figure 16. 900 V – 15% to 85%

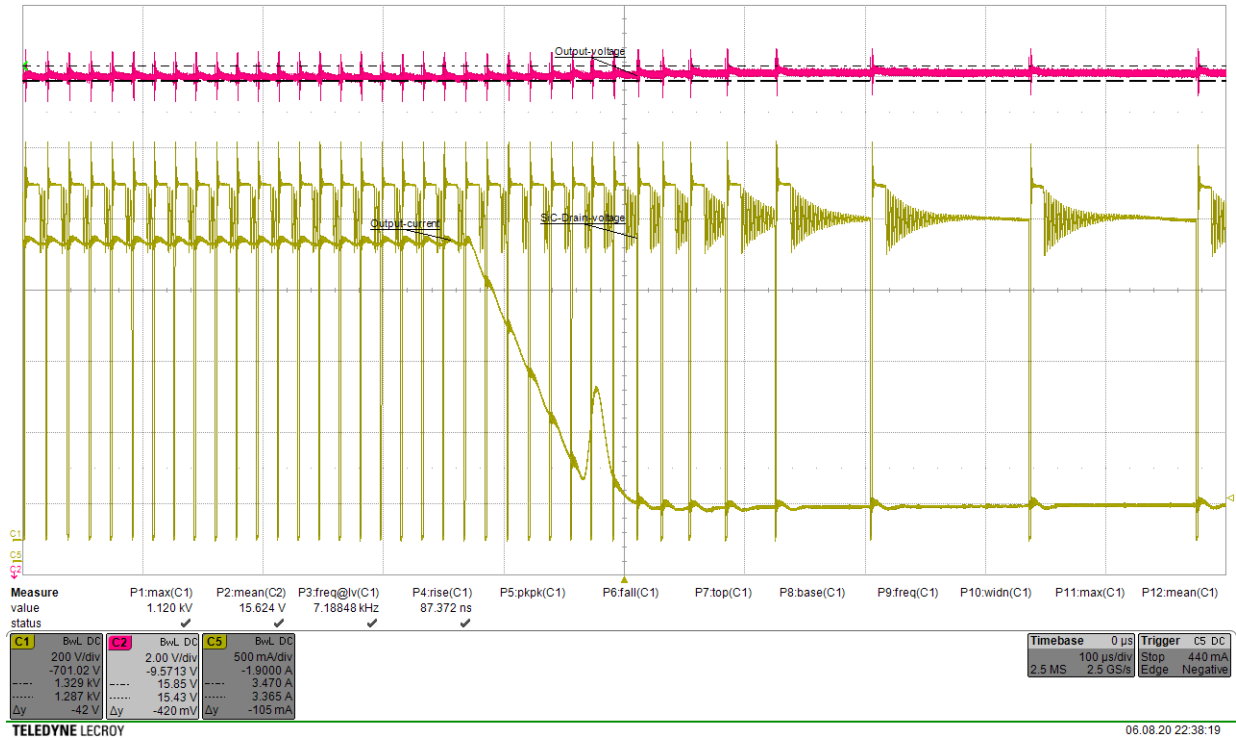

Figure 17. 900 V – 85% to 15%

SECO-HVDCDC1362-40W-GEVB

Thermal Camera View

Measured conditions:

- Output power $P_{out} \sim 40\text{ W}$
 - Electronic load: Chroma 6147A used channel 3 as CRH (constant resistance high mode $5.5\ \Omega \rightarrow 2.66\text{ A}$)
- Input voltage $\sim 900\text{ V DC}$
 - After 5 minutes in this conditions

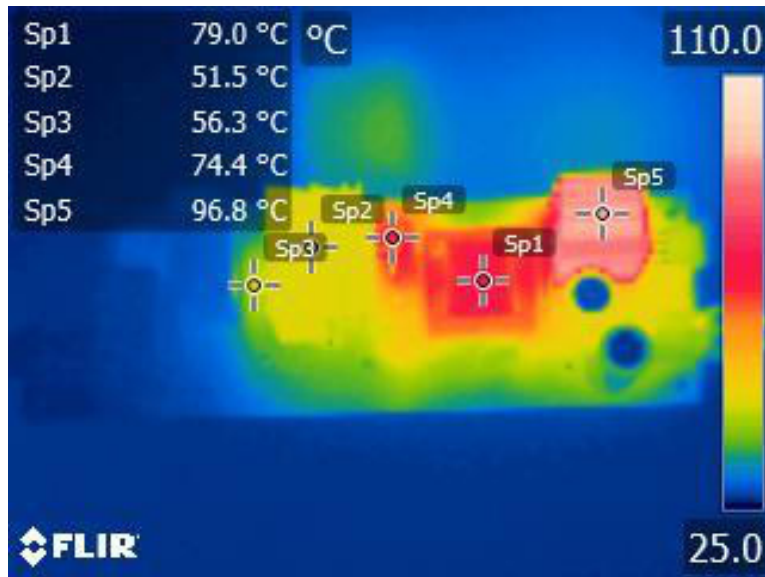

Sp1 – Transformer
Sp2 – SiC switcher heatsink
Sp3 – Startup high voltage resistor
Sp4 – Axial TVS diode
Sp5 – Secondary rectifier heatsink

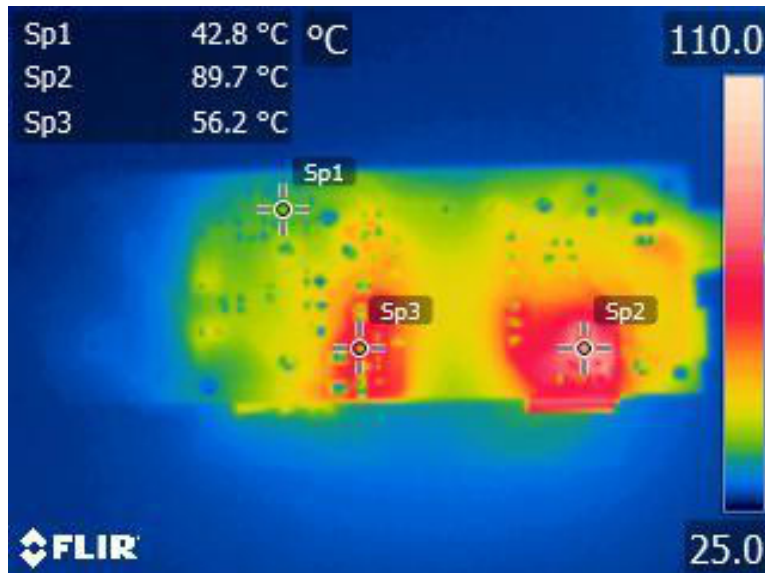

Sp1 – IC NCV 1362
Sp2 – Secondary rectifier heatsink bottom
Sp3 – Axial TVS diode bottom side

Figure 18.

SECO-HVDCDC1362-40W-GEVB

Measured conditions:

- Output power $P_{out} \sim 40\text{ W}$
- Electronic load: Chroma 6147A used channel 3 as CRH (constant resistance high mode $5.5\ \Omega \rightarrow 2.66\text{ A}$)
- Input voltage $\sim 250\text{ V DC}$
- After 5 minutes in this conditions

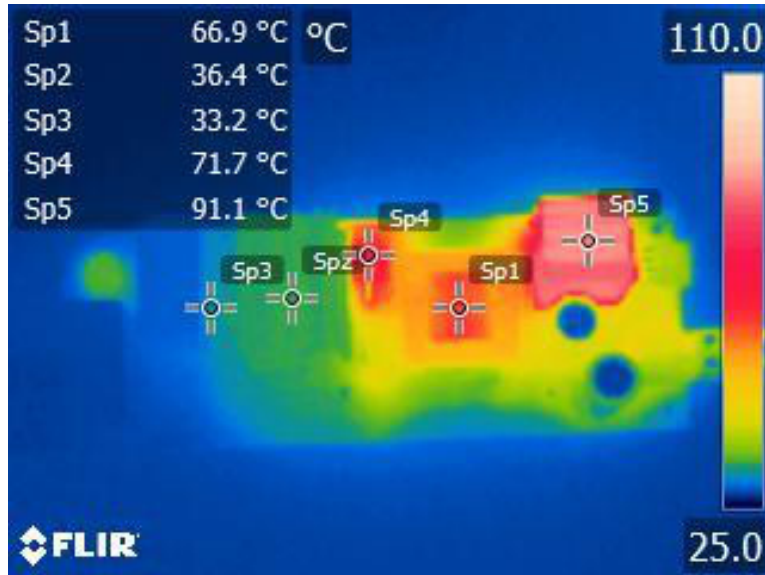

Sp1 – Transformer
Sp2 – SiC switcher heatsink
Sp3 – Startup high voltage resistor
Sp4 – Axial TVS diode
Sp5 – Secondary rectifier heatsink

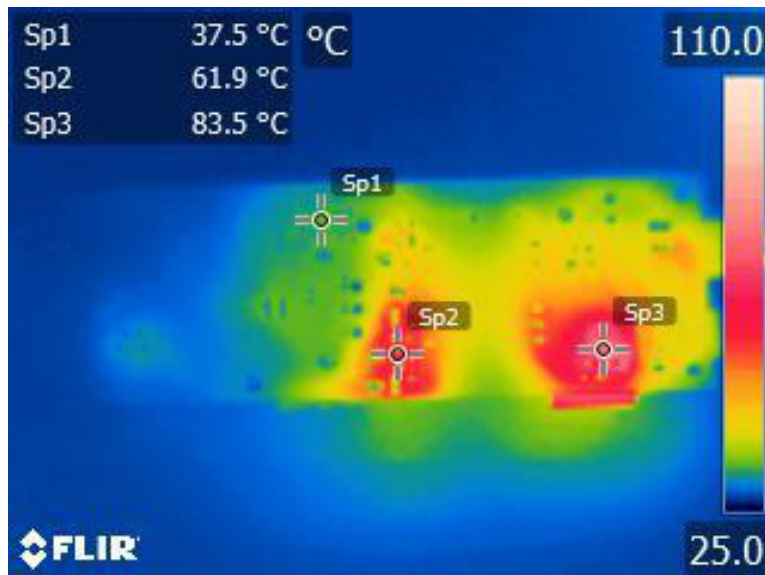

Sp1 – IC NCV 1362
Sp2 – Secondary rectifier heatsink bottom
Sp3 – Axial TVS diode bottom side

Figure 19.

SECO-HVDCDC1362-40W-GEVB

Electromagnetic Compatibility – Conducted Emissions EN55015 Limits

Measured conditions:

- Output power $P_{out} \sim 18 \Omega$ resistive load
- Input voltage $\sim 250 \text{ V}$

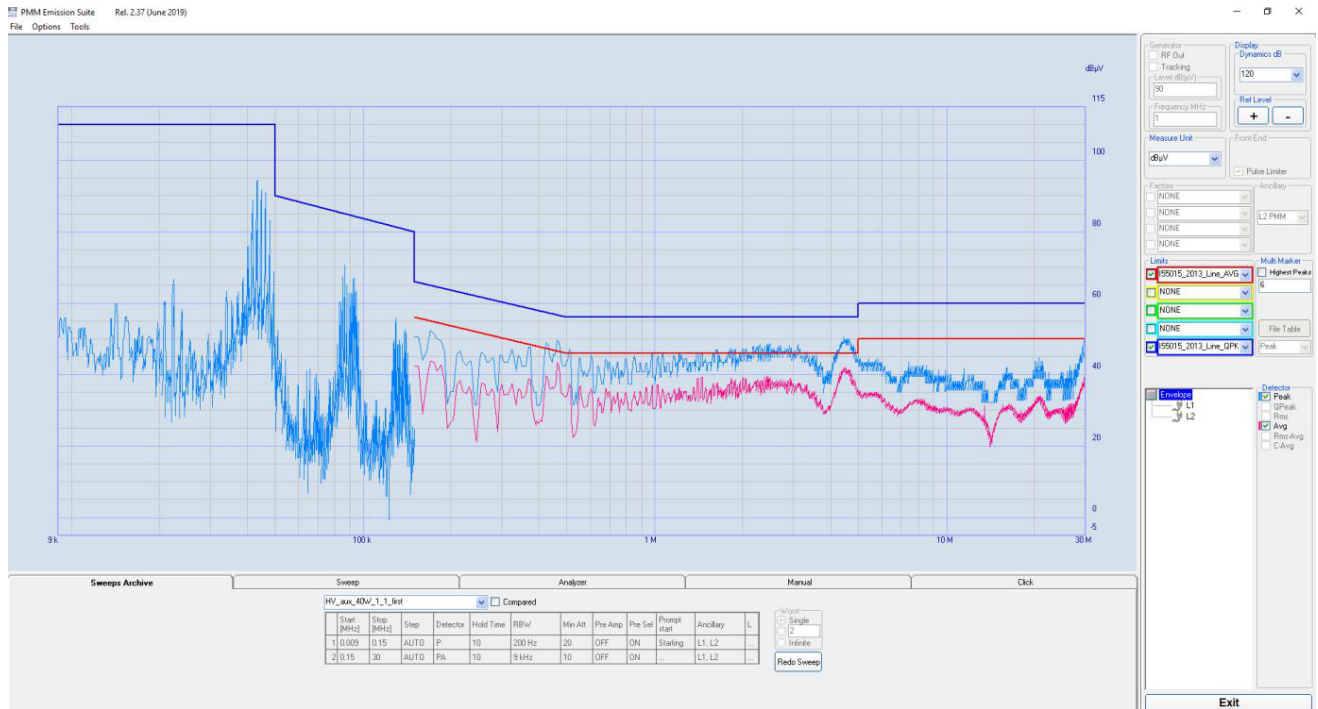

Figure 20.

SECO-HVDCDC1362-40W-GEVB

Transformer Design

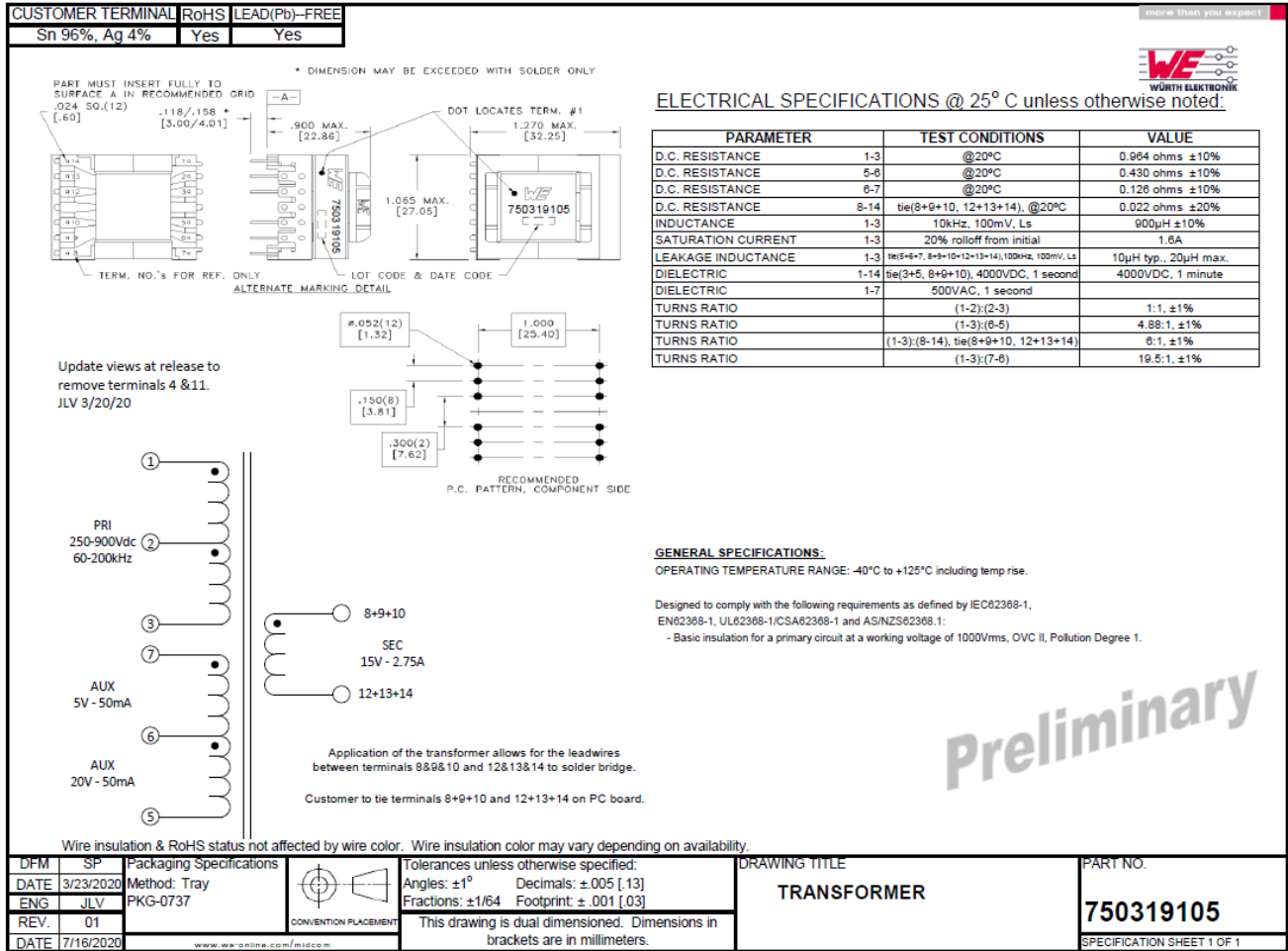

Figure 21. Drawing and Parameters of Used Transformer

SECO-HVDCDC1362-40W-GEVB

Development Resources and Tools

Collateral, development files and other development resources listed below are available at [SECO-HVDCDC1362-40W-GEVB](http://www.onsemi.com/SECO-HVDCDC1362-40W-GEVB)

- Schematics
- BOM (below as well)
- Manufacturing files
- PCB layout (below as well)
- Source files
- Simulation model (below as well)

Table 1. BILL OF MATERIALS

#	Designator	Comment	Description
1.	C2	470 pF	MLC capacitor 470pF 1kV ±10% X7R Würth Elektronik
2.	C5	100 nF	Multilayer Ceramic Capacitors MLCC – SMD 1206 25 V 100 nF C0G ± 1 % AEC-Q202 –55 – 125 °C
3.	C6, C18	1000 µF	ALU electrolyte high current ripple 1000 µF 25V 20% Nichicon
4.	C7	470 nF	Multilayer Ceramic Capacitors MLCC – SMD 0805 50 V 470 nF X7R ± 10 % AEC-Q202 –55 – 125 °C
5.	C8	4.7 µF	Multilayer Ceramic Capacitors MLCC – SMD 1210 50 V 4.7 µF X7R ± 10 % AEC-Q202 –55 – 125 °C
6.	C9	100 nF	Multilayer Ceramic Capacitors MLCC – SMD 1206 50 V 100 nF C0G ± 5 % AEC-Q202 –55 – 125 °C
7.	C10, C15	120 pF	Multilayer Ceramic Capacitors MLCC – SMD 0603 100 V 120 pF C0G ± 5 % AEC-Q202 –55 – 125 °C
8.	C12	150 nF	Multilayer Ceramic Capacitors MLCC – SMD 0603 25 V 150 nF X7R ± 10 % AEC-Q202 –55 – 125 °C
9.	C13	1n8	Multilayer Ceramic Capacitors MLCC – SMD 0805 100 V 1n8 C0G ± 5 % AEC-Q202 –55 – 125 °C
10.	C14	3n3	Multilayer Ceramic Capacitors MLCC – SMD 0805 100 V 3n3 C0G ± 5 % AEC-Q202 –55 – 125 °C
11.	C17	4.7 pF	Multilayer Ceramic Capacitors MLCC – SMD 0603 100 V 4.7 pF C0G ± 5 % AEC-Q200 –55 – 125 °C
12.	C19, C20	220 nF	MMKT film capacitor 220n 500Vac/1600Vdc TDK
13.	CON1	RED	Banana Test Connector, 4mm, Receptacle, PCB Mount, 24 A, 1 kV, Gold Plated Contacts, Red
14.	CON2	691 313 510 002	PCB right angle connector 2 pins 5.08 mm pitch Würth Elektronik
15.	CON3	BLACK	Banana Test Connector, 4mm, Receptacle, PCB Mount, 24 A, 1 kV, Gold Plated Contacts, Black
16.	CON4	613 008 243 121	WR-PHD 2.54 mm Angled Dual Socket Header 2x4 pins
17.	CON5	691 351 500 002	Cable connector series 351 2pins 5.08 mm Würth Elektronik
18.	CY1	2n2	Disc ceramic capacitor 2n2 1500 VDC Y5U 10 % Vishay AEC-Q200
19.	D1	FFSP1065B-F085	Ultra fast Schottky SiC diode 650V 10A AEC-Q101 ON Semiconductor
20.	D3	SZ1SMA5931BT3G	TVS zener diode 18 V 83 mA SMA AEC-Q101 ON Semiconductor
21.	D4	NRVUS1MFA	Super Fast diode 1000 V 1 A 75 ns SOD123FA AEC-Q101, ON Semiconductor
22.	D5	NSVBAS21AHT1G	Switching diode 250V 200mA SOD323 AEC-Q101 ON Semiconductor
23.	D6	SZMMSZ18T1G	Zener Single Diode, 18 V, 500 mW, SOD-123, 5 %, 2 Pins, 150 °C, AEC-Q101
24.	D7	5KP160A	TVS 160V 5000W True hole unidirectional VISHAY AEC-Q101
25.	D8	SZMMSZ20T1G	Zener Diodes 20V 500mW SOD123 AEC-Q101 ON Semiconductor
26.	D9	NRVBA130LT3G	Schottky diode 30 V 1 A SMA ON Semiconductor
27.	HS1	SK 526 30 mm black anodized	Heatsink Fischer Elektronik SK 526 30 mm black anodized
28.	HS2	SK 525 20 mm black anodized	Heatsink Fischer Elektronik SK 525 20 mm black anodized
29.	IC1	NCV1362BA	Automotive Primary Side Flyback Controller
30.	L1	2.2 mH	Fixed Inductors RFB 1010 Lead Rad 2.2 mH 0.41A 4.1 Ω

SECO-HVDCDC1362-40W-GEVB

Table 1. BILL OF MATERIALS (continued)

#	Designator	Comment	Description
31.	L2	470 μ H	Fixed Inductors RFB 1010 Lead Rad 470 μ H 0.9A 0.81 Ω
32.	Q1	NSVBC817-40W	General purpose NPN transistor 45V 500mA ON Semiconductor
33.	Q3	NVHL160N120SC1	SiC NMOS 1200V 17A 160 m Ω ON Semiconductor
34.	R1	68R	SMD thick film resistor 68R 1206 1% 660 mW Panasonic
35.	R3	6M8	High Ohmic / High Voltage Metal Glaze Leaded Resistors 0207 6M8 5% 250 mW Vishay
36.	R4	10M	High Ohmic / High Voltage Metal Glaze Leaded Resistors 0207 10M 5% 250 mW Vishay
37.	R5, R6, R9	100k	SMD Chip Resistor, 100 k Ω , MCWR Series, 200 V, Thick Film, 1206 [3216 Metric], 250 mW Multicomp
38.	R10, R19	0R	SMD Chip Resistor, 0 Ω , ERJ8G Series, 200 V, Thick Film, 1206 [3216 Metric], 250 mW Panasonic
39.	R13	4k7	SMD thick film resistor 4k7 0603 1% 100 mW Panasonic
40.	R17	154k	SMD thick film resistor 154k 0805 1% 125 mW Panasonic
41.	R24	270k	SMD thick film resistor 270k 0603 1% 100 mW Panasonic
42.	R25	10k	SMD thick film resistor 10k 0805 1% 125 mW Panasonic
43.	R26	8R2	SMD thick film resistor 8 Ω 1206 1% 500 mW Panasonic
44.	R28	1k	SMD thick film resistor 1k 1206 1% 250 mW Panasonic
45.	R29	100k	SMD Thermistor, 100 k Ω , NTCG-S Series, 0805 [2012 Metric], 200 mW TDK
46.	R30	34k8	SMD thick film resistor 34k8 0603 1% 100 mW Panasonic
47.	R31, R32	0R56	SMD thick film resistor 0.56 Ω 1206 1% 500 mW Panasonic
48.	R33	51k1	SMD thick film resistor 51k1 0603 1% 100 mW Panasonic
49.	R34	44k2	SMD thick film resistor 44k2 0603 1% 100 mW Panasonic
50.	SB1, SB2, SB3, SB4	Plastic spacer M3 M/F 8/5 HEX6	Plastic spacer internal/external M3x8 thread, 5 mm Würth Elektronik
51.	ST1, ST2, ST3, ST4	Plastic spacer M3 F/F 10/40 HEX6	Plastic spacer internal/internal M3x6 thread, 40 mm Würth Elektronik
52.	T1	750319105	Transformer for DC-DC (NCV1362 flyback 250V-900VDC@40W) converter from Würth Elektronik
53.	TP1	ORANGE	PTH testpoint eyelet 3.2mm orange Keystone Electronics
54.	TP2, TP5	RED	PTH testpoint eyelet 3.2mm red Keystone Electronics
55.	TP3	BROWN	PTH testpoint eyelet 3.2mm brown Keystone Electronics
56.	TP4	BLUE	PTH testpoint eyelet 3.2mm blue Keystone Electronics
57.	TP6	BLACK	PTH testpoint eyelet 3.2mm black Keystone Electronics
58.	W1	AOS247 23x20x1	Ceramic insulation washer without hole for TO247 1mm Fischer Elektronik

SECO-HVDCDC1362-40W-GEVB

Layout

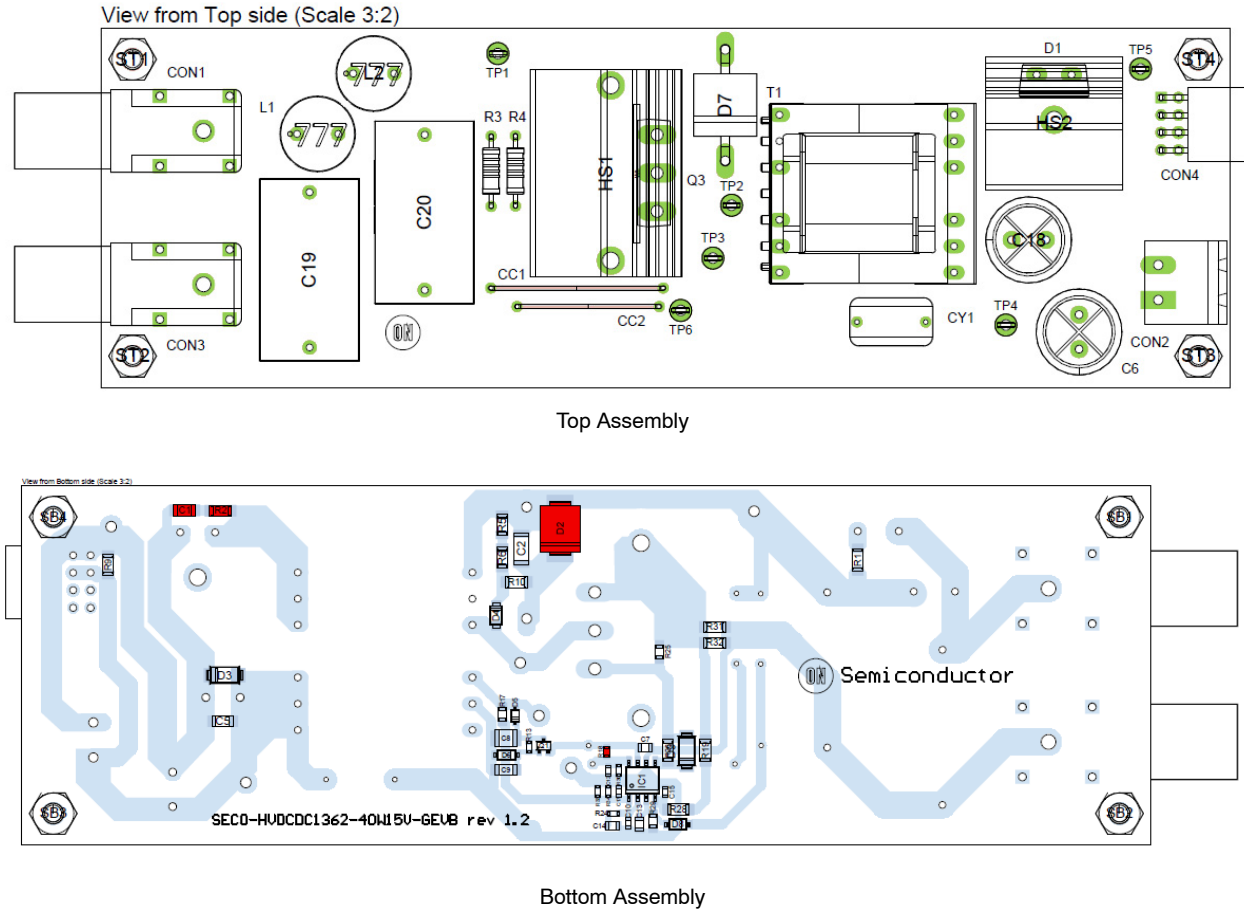

Figure 22. Layout

References

- NCV1362 Data sheet
- NCV1362 Application notes
- NCV1362 [Evaluation boards](#)
- NCV1362 Design worksheet MathCad

onsemi, **Onsemi**, and other names, marks, and brands are registered and/or common law trademarks of Semiconductor Components Industries, LLC dba "**onsemi**" or its affiliates and/or subsidiaries in the United States and/or other countries. **onsemi** owns the rights to a number of patents, trademarks, copyrights, trade secrets, and other intellectual property. A listing of **onsemi**'s product/patent coverage may be accessed at www.onsemi.com/site/pdf/Patent-Marking.pdf. **onsemi** is an Equal Opportunity/Affirmative Action Employer. This literature is subject to all applicable copyright laws and is not for resale in any manner.

The evaluation board/kit (research and development board/kit) (hereinafter the "board") is not a finished product and is not available for sale to consumers. The board is only intended for research, development, demonstration and evaluation purposes and will only be used in laboratory/development areas by persons with an engineering/technical training and familiar with the risks associated with handling electrical/mechanical components, systems and subsystems. This person assumes full responsibility/liability for proper and safe handling. Any other use, resale or redistribution for any other purpose is strictly prohibited.

THE BOARD IS PROVIDED BY ONSEMI TO YOU "AS IS" AND WITHOUT ANY REPRESENTATIONS OR WARRANTIES WHATSOEVER. WITHOUT LIMITING THE FOREGOING, ONSEMI (AND ITS LICENSORS/SUPPLIERS) HEREBY DISCLAIMS ANY AND ALL REPRESENTATIONS AND WARRANTIES IN RELATION TO THE BOARD, ANY MODIFICATIONS, OR THIS AGREEMENT, WHETHER EXPRESS, IMPLIED, STATUTORY OR OTHERWISE, INCLUDING WITHOUT LIMITATION ANY AND ALL REPRESENTATIONS AND WARRANTIES OF MERCHANTABILITY, FITNESS FOR A PARTICULAR PURPOSE, TITLE, NON-INFRINGEMENT, AND THOSE ARISING FROM A COURSE OF DEALING, TRADE USAGE, TRADE CUSTOM OR TRADE PRACTICE.

onsemi reserves the right to make changes without further notice to any board.

You are responsible for determining whether the board will be suitable for your intended use or application or will achieve your intended results. Prior to using or distributing any systems that have been evaluated, designed or tested using the board, you agree to test and validate your design to confirm the functionality for your application. Any technical, applications or design information or advice, quality characterization, reliability data or other services provided by **onsemi** shall not constitute any representation or warranty by **onsemi**, and no additional obligations or liabilities shall arise from **onsemi** having provided such information or services.

onsemi products including the boards are not designed, intended, or authorized for use in life support systems, or any FDA Class 3 medical devices or medical devices with a similar or equivalent classification in a foreign jurisdiction, or any devices intended for implantation in the human body. You agree to indemnify, defend and hold harmless **onsemi**, its directors, officers, employees, representatives, agents, subsidiaries, affiliates, distributors, and assigns, against any and all liabilities, losses, costs, damages, judgments, and expenses, arising out of any claim, demand, investigation, lawsuit, regulatory action or cause of action arising out of or associated with any unauthorized use, even if such claim alleges that **onsemi** was negligent regarding the design or manufacture of any products and/or the board.

This evaluation board/kit does not fall within the scope of the European Union directives regarding electromagnetic compatibility, restricted substances (RoHS), recycling (WEEE), FCC, CE or UL, and may not meet the technical requirements of these or other related directives.

FCC WARNING – This evaluation board/kit is intended for use for engineering development, demonstration, or evaluation purposes only and is not considered by **onsemi** to be a finished end product fit for general consumer use. It may generate, use, or radiate radio frequency energy and has not been tested for compliance with the limits of computing devices pursuant to part 15 of FCC rules, which are designed to provide reasonable protection against radio frequency interference. Operation of this equipment may cause interference with radio communications, in which case the user shall be responsible, at its expense, to take whatever measures may be required to correct this interference.

onsemi does not convey any license under its patent rights nor the rights of others.

LIMITATIONS OF LIABILITY: **onsemi** shall not be liable for any special, consequential, incidental, indirect or punitive damages, including, but not limited to the costs of requalification, delay, loss of profits or goodwill, arising out of or in connection with the board, even if **onsemi** is advised of the possibility of such damages. In no event shall **onsemi**'s aggregate liability from any obligation arising out of or in connection with the board, under any theory of liability, exceed the purchase price paid for the board, if any.

The board is provided to you subject to the license and other terms per **onsemi**'s standard terms and conditions of sale. For more information and documentation, please visit www.onsemi.com.

ADDITIONAL INFORMATION

TECHNICAL PUBLICATIONS:

Technical Library: www.onsemi.com/design/resources/technical-documentation
onsemi Website: www.onsemi.com

ONLINE SUPPORT: www.onsemi.com/support

For additional information, please contact your local Sales Representative at www.onsemi.com/support/sales