

OBC LLC resonant tank WE board		Assembly variant:	State:
Resonant tank board		standard_board	released
Revision: 0.1	Repository revision: 1264		ON Semiconductor Solution Engineering Center Piešťany
Engineer: Stefan Kosterec	18.Oct 2018 20:23		
File: OBC_LL_C_resonant_tank_WE_board.SchDoc	1/2		

Back panel

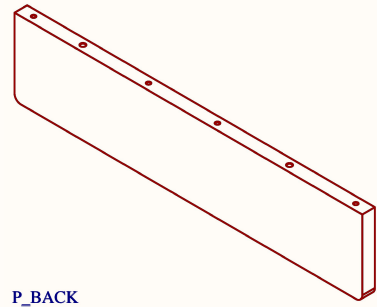

P_BACK
custom plastic back panel for OBC LLC board with WE parts

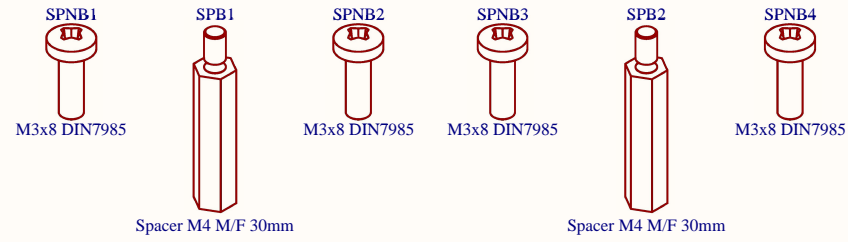

Fan with fixing parts

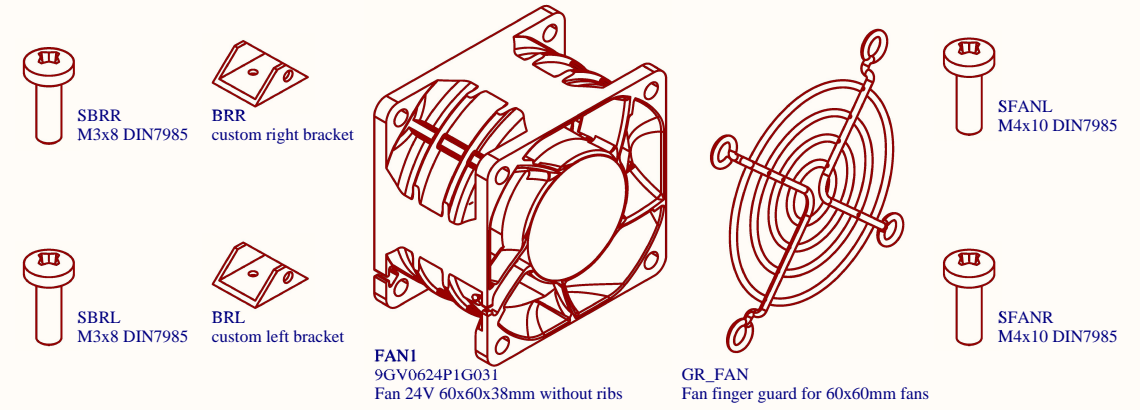

Fan connection parts

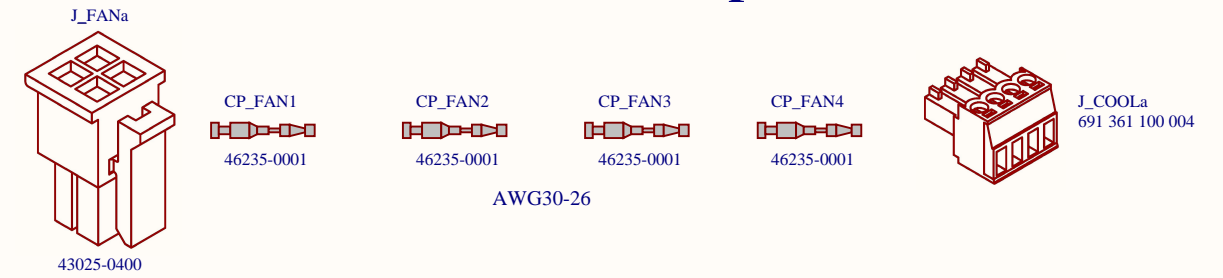

Front panel

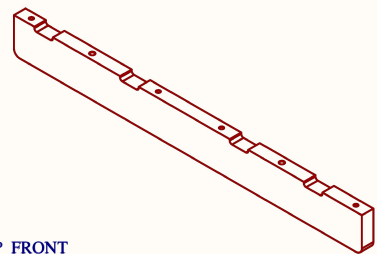

P_FRONT
custom plastic front panel for OBC LLC board with WE parts

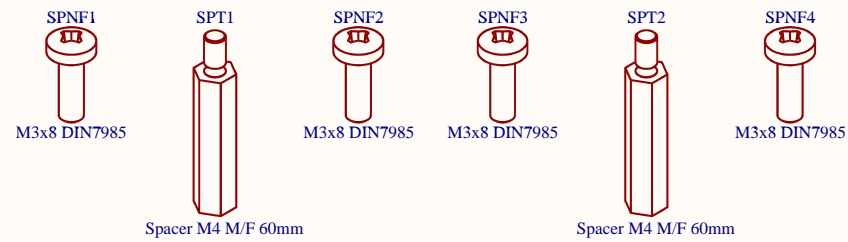

Terminals connection parts

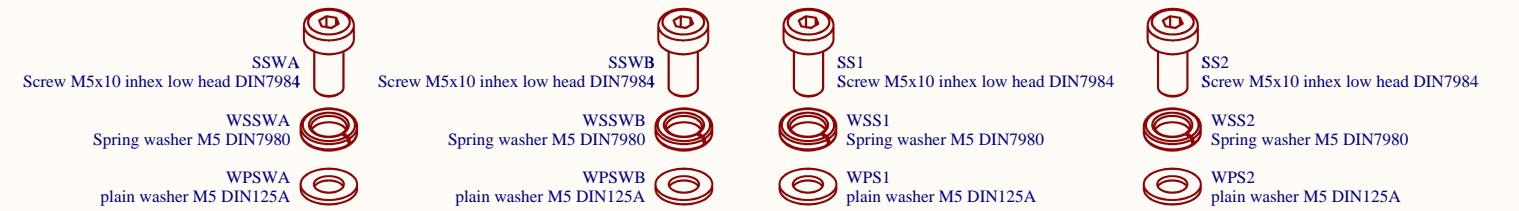

OBC LLC resonant tank WE board		Assembly variant:	State:
Mechanical parts		standard_board	released
Revision: 0.1	Repository revision: 1264		ON Semiconductor Solution Engineering Center Piešťany
Engineer: Stefan Kosterec	18.Oct 2018 20:23		
File: mechanical_parts.SchDoc	2/2		

