

# 3.3 V 2:1:9 Differential HSTL/PECL/LVDS to HSTL Clock Driver with LVTTTL Clock Select and Enable



ON Semiconductor®

[www.onsemi.com](http://www.onsemi.com)

## MC100EP809

### Description

The MC100EP809 is a low skew 2:1:9 differential clock driver, designed with clock distribution in mind, accepting two clock sources into an input multiplexer. The part is designed for use in low voltage applications which require a large number of outputs to drive precisely aligned low skew signals to their destination. The two clock inputs are one differential HSTL and one differential LVPECL. Both input pairs can accept LVDS levels. They are selected by the CLK\_SEL pin which is LVTTTL. To avoid generation of a runt clock pulse when the device is enabled/disabled, the Output Enable (OE), which is LVTTTL, is synchronous ensuring the outputs will only be enabled/disabled when they are already in LOW state (Figure 8).

The MC100EP809 guarantees low output-to-output skew. The optimal design, layout, and processing minimize skew within a device and from lot to lot. The MC100EP809 output structure uses open emitter architecture and will be terminated with 50 Ω to ground instead of a standard HSTL configuration (Figure 6). To ensure the tight skew specification is realized, both sides of the differential output need to be terminated identically into 50 Ω even if only one output is being used. If an output pair is unused, both outputs may be left open (unterminated) without affecting skew.

Designers can take advantage of the EP809's performance to distribute low skew clocks across the backplane of the board. Both clock inputs may be single-end driven by biasing the non-driven pin in an input pair (Figure 7).

### Features

- 100 ps Typical Device-to-Device Skew
- 15 ps Typical within Device Skew
- HSTL Compatible Outputs Drive 50 Ω to GND with no Offset Voltage
- Maximum Frequency > 750 MHz
- 850 ps Typical Propagation Delay
- Fully Compatible with Micrel SY89809L
- PECL and HSTL Mode Operating Range:  $V_{CCI} = 3\text{ V to }3.6\text{ V}$  with  $GND = 0\text{ V}$ ,  $V_{CCO} = 1.6\text{ V to }2.0\text{ V}$
- Open Input Default State
- This Device is Pb-Free and is RoHS Compliant

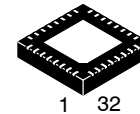

QFN32  
MN SUFFIX  
CASE 488AM

### MARKING DIAGRAM\*

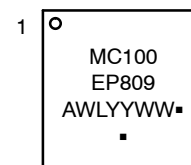

- A = Assembly Location
  - WL = Wafer Lot
  - YY = Year
  - WW = Work Week
  - = Pb-Free Package
- (Note: Microdot may be in either location)

\*For additional marking information, refer to Application Note [AND8002/D](#).

### ORDERING INFORMATION

Device	Package	Shipping
MC100EP809MNG	QFN32 (Pb-Free)	74 Units / Rail

# MC100EP809

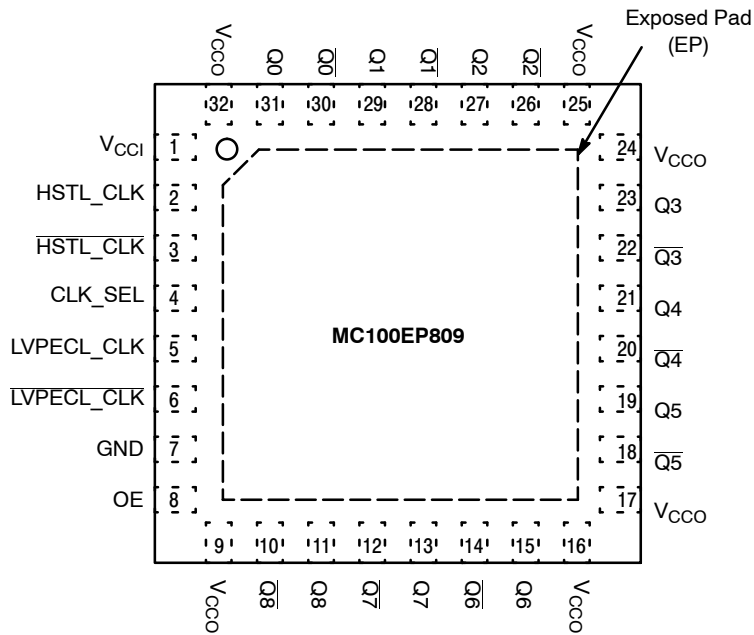

Figure 1. 32-Lead QFN Pinout (Top View)

Table 1. PIN DESCRIPTION

PIN	FUNCTION
HSTL_CLK*, HSTL_CLK**	HSTL or LVDS Differential Inputs
LVPECL_CLK*, LVPECL_CLK**	LVPECL or LVDS Differential Inputs
CLK_SEL**	LVC MOS/LVTTL Input CLK Select
OE**	LVC MOS/LVTTL Output Enable
Q0 – Q8, Q0 – Q8	HSTL Differential Outputs
V <sub>CC1</sub>	Positive Supply_Core (3.0 V – 3.6 V)
V <sub>CC0</sub>	Positive Supply_HSTL Outputs (1.6 V – 2.0 V)
GND	Ground
EP	The exposed pad (EP) on the QFN-32 package bottom is thermally connected to the die for improved heat transfer out of the package. The exposed pad must be attached to a heat-sinking conduit. The pad is electrically connected to GND.

\* Pins will default LOW when left open.

\*\* Pins will default HIGH when left open.

Table 2. TRUTH TABLE

OE*	CLK_SEL	Q0 – Q8	$\overline{Q0 - Q8}$
L	L	L	H
L	H	L	H
H	L	HSTL_CLK	HSTL_CLK
H	H	LVPECL_CLK	LVPECL_CLK

\*The OE (Output Enable) signal is synchronized with the rising edge of the HSTL\_CLK and LVPECL\_CLK signals.

# MC100EP809

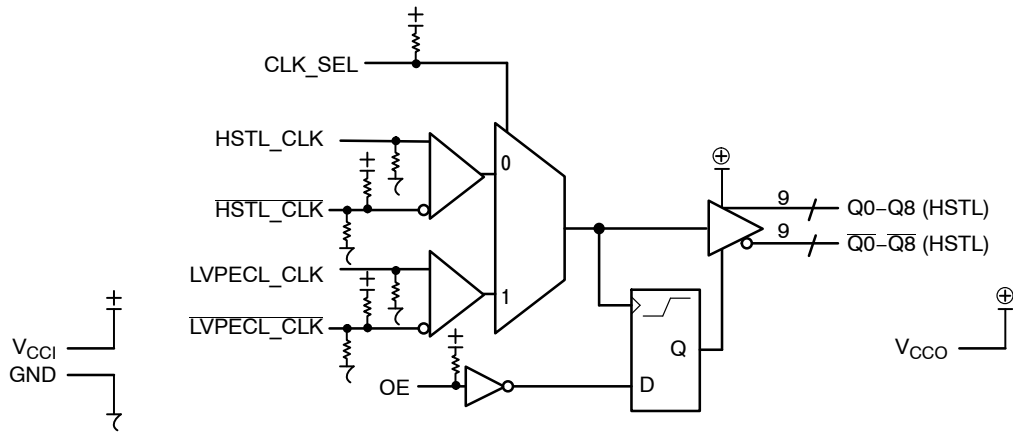

Figure 2. Logic Diagram

Table 3. ATTRIBUTES

Characteristics	Value
Internal Input Pulldown Resistor	75 k $\Omega$
Internal Input Pullup Resistor	37.5 k $\Omega$
ESD Protection Human Body Model Machine Model Charged Device Model	> 2 kV > 200 V > 2 kV
Moisture Sensitivity, Indefinite Time Out of Drypack (Note 1)	Pb-Free Pkg
QFN-32	Level 1
Flammability Rating Oxygen Index: 28 to 34	UL 94 V-0 @ 0.125 in
Transistor Count	478 Devices
Meets or exceeds JEDEC Spec EIA/JESD78 IC Latchup Test	

1. For additional information, see Application Note [AND8003/D](#).

Table 4. MAXIMUM RATINGS

Symbol	Parameter	Condition 1	Condition 2	Rating	Unit
V <sub>CC1</sub>	Core Power Supply	GND = 0 V	V <sub>CC0</sub> = 1.6 to 2.0 V	4	V
V <sub>CC0</sub>	HSTL Output Power Supply	GND = 0 V	V <sub>CC1</sub> = 3.0 to 3.6 V	4	V
V <sub>I</sub>	Input Voltage	GND = 0 V	V <sub>I</sub> $\leq$ V <sub>CC1</sub>	4	V
I <sub>out</sub>	Output Current	Continuous Surge		50 100	mA mA
T <sub>A</sub>	Operating Temperature Range			0 to +85	$^{\circ}$ C
T <sub>stg</sub>	Storage Temperature Range			-65 to +150	$^{\circ}$ C
$\theta_{JA}$	Thermal Resistance (Junction-to-Ambient)	0 lfpm 500 lfpm		31 27	$^{\circ}$ C/W $^{\circ}$ C/W
$\theta_{JC}$	Thermal Resistance (Junction-to-Case)	2S2P		12	$^{\circ}$ C/W
T <sub>sol</sub>	Wave Solde			265	$^{\circ}$ C

Stresses exceeding those listed in the Maximum Ratings table may damage the device. If any of these limits are exceeded, device functionality should not be assumed, damage may occur and reliability may be affected.

# MC100EP809

**Table 5. LVPECL DC CHARACTERISTICS**  $V_{CCI} = 3.0\text{ V to }3.6\text{ V}$ ;  $V_{CCO} = 1.6\text{ V to }2.0\text{ V}$ ,  $GND = 0\text{ V}$

Symbol	Characteristic	0°C			25°C			85°C			Unit
		Min	Typ	Max	Min	Typ	Max	Min	Typ	Max	
$I_{CC}$	Core Power Supply Current	75	95	115	75	95	115	75	95	115	mA
$V_{IH}$	Input HIGH Voltage (Single-Ended)	$V_{CCI} - 1.165$		$V_{CCI} - 0.88$	$V_{CCI} - 1.165$		$V_{CCI} - 0.88$	$V_{CCI} - 1.165$		$V_{CCI} - 0.88$	V
$V_{IL}$	Input LOW Voltage (Single-Ended)	$V_{CCI} - 1.945$		$V_{CCI} - 1.6$	$V_{CCI} - 1.945$		$V_{CCI} - 1.6$	$V_{CCI} - 1.945$		$V_{CCI} - 1.6$	V
$V_{IHCMR}$	Input HIGH Voltage Common Mode Range (Differential Configuration) (Note 2) (Figure 4) LVPECL_CLK/LVPECL_CLK	1.2		$V_{CCI}$	1.2		$V_{CCI}$	1.2		$V_{CCI}$	V
$I_{IH}$	Input HIGH Current	-150		150	-150		150	-150		150	$\mu\text{A}$
$I_{IL}$	Input LOW Current	-150		150	-150		150	-150		150	$\mu\text{A}$

NOTE: Device will meet the specifications after thermal equilibrium has been established when mounted in a test socket or printed circuit board with maintained transverse airflow greater than 500 lpm.

2.  $V_{IHCMR}$  max varies 1:1 with  $V_{CCI}$ . The  $V_{IHCMR}$  range is referenced to the most positive side of the differential input signal.

**Table 6. LVTTTL/LVC MOS DC CHARACTERISTICS**  $V_{CCI} = 3.0\text{ V to }3.6\text{ V}$ ;  $V_{CCO} = 1.6\text{ V to }2.0\text{ V}$ ,  $GND = 0\text{ V}$

Symbol	Characteristic	0°C			25°C			85°C			Unit
		Min	Typ	Max	Min	Typ	Max	Min	Typ	Max	
$V_{IH}$	Input HIGH Voltage	2.0			2.0			2.0			V
$V_{IL}$	Input LOW Voltage			0.8			0.8			0.8	V
$I_{IH}$	Input HIGH Current	-150		150	-150		150	-150		150	$\mu\text{A}$
$I_{IL}$	Input LOW Current	-300		300	-300		300	-300		300	$\mu\text{A}$

NOTE: Device will meet the specifications after thermal equilibrium has been established when mounted in a test socket or printed circuit board with maintained transverse airflow greater than 500 lpm.

**Table 7. HSTL DC CHARACTERISTICS**  $V_{CCI} = 3.0\text{ V to }3.6\text{ V}$ ;  $V_{CCO} = 1.6\text{ V to }2.0\text{ V}$ ,  $GND = 0\text{ V}$

Symbol	Characteristic	0°C			25°C			85°C			Unit
		Min	Typ	Max	Min	Typ	Max	Min	Typ	Max	
$V_{OH}$	Output HIGH Voltage (Note 3)	1.0		1.2	1.0		1.2	1.0		1.2	V
$V_{OL}$	Output LOW Voltage (Note 3)	0.1		0.4	0.1		0.4	0.1		0.4	V
$V_{IH}$	Input HIGH Voltage (Figure 5)	$V_X + 0.1$		1.6	$V_X + 0.1$		1.6	$V_X + 0.1$		1.6	V
$V_{IL}$	Input LOW Voltage (Figure 5)	-0.3		$V_X - 0.1$	-0.3		$V_X - 0.1$	-0.3		$V_X - 0.1$	V
$V_X$	HSTL Input Crossover Voltage	0.68	-	0.9	0.68	-	0.9	0.68	-	0.9	V
$I_{IH}$	Input HIGH Current	-150		150	-150		150	-150		150	$\mu\text{A}$
$I_{IL}$	Input LOW Current	-300		300	-300		300	-300		300	$\mu\text{A}$
$V_{IHCMR}$	Input HIGH Voltage Common Mode Range (Differential Configuration) (Note 4) HSTL_CLK/HSTL_CLK	0.6		$V_{CCI} - 1.2$	0.6		$V_{CCI} - 1.2$	0.6		$V_{CCI} - 1.2$	V

NOTE: Device will meet the specifications after thermal equilibrium has been established when mounted in a test socket or printed circuit board with maintained transverse airflow greater than 500 lpm.

3. All outputs loaded with 50  $\Omega$  to GND (Figure 6).

4.  $V_{IHCMR}$  max varies 1:1 with  $V_{CCI}$ . The  $V_{IHCMR}$  range is referenced to the most positive side of the differential input signal.

# MC100EP809

**Table 8. AC CHARACTERISTICS**  $V_{CCI} = 3.0\text{ V to }3.6\text{ V}$ ;  $V_{CCO} = 1.6\text{ V to }2.0\text{ V}$ ,  $GND = 0\text{ V}$  (Note 5)

Symbol	Characteristic	0°C			25°C			85°C			Unit
		Min	Typ	Max	Min	Typ	Max	Min	Typ	Max	
$V_{OPP}$	Differential Output Voltage (Figure 3)										
	$f_{out} < 100\text{ MHz}$	600	850		600	850		600	850		mV
	$f_{out} < 500\text{ MHz}$	600	750		600	750		600	750		mV
	$f_{out} < 750\text{ MHz}$	450	575		450	575		450	575		mV
$t_{PLH}$ $t_{PHL}$	Propagation Delay (Differential Configuration) LVPECL_CLK to Q HSTL_CLK to Q										
		680	800	930	700	820	950	780	920	1070	ps
		690	830	990	700	850	1000	790	950	1110	ps
$t_{skew}$	Within-Device Skew (Note 6)		15	50		15	50		15	50	ps
	Device-to-Device Skew (Note 7)		100	200		100	200		100	200	ps
$t_{JITTER}$	Random Clock Jitter (Figure 3) (RMS)		1.4	3.0		1.4	3.0		1.4	3.0	ps
$V_{PP}$	Input Swing (Differential Configuration) (Note 8) (Figure 4) LVPECL HSTL										
		200			200			200			mV
		200			200			200			mV
$t_S$	OE Set Up Time (Note 9)	0.5			0.5			0.5			ns
$t_H$	OE Hold Time	0.5			0.5			0.5			ns
$t_r/t_f$	Output Rise/Fall Time (20% – 80%)	350		600	350	450	600	350		600	ps

NOTE: Device will meet the specifications after thermal equilibrium has been established when mounted in a test socket or printed circuit board with maintained transverse airflow greater than 500 lfm.

5. Measured with 750 mV (LVPECL) source or 1 V (HSTL) source, 50% duty cycle clock source. All outputs loaded with 50  $\Omega$  to GND (Figure 6).
6. Skew is measured between outputs under identical transitions and conditions on any one device.
7. Device-to-Device skew for identical transitions and conditions.
8.  $V_{PP}$  is the Differential Input Voltage swing required to maintain AC characteristics listed herein.
9. OE Set Up Time is defined with respect to the rising edge of the clock. OE High-to-Low transition ensures outputs remain disabled during the next clock cycle. OE Low-to-High transition enables normal operation of the next input clock (Figure 8).

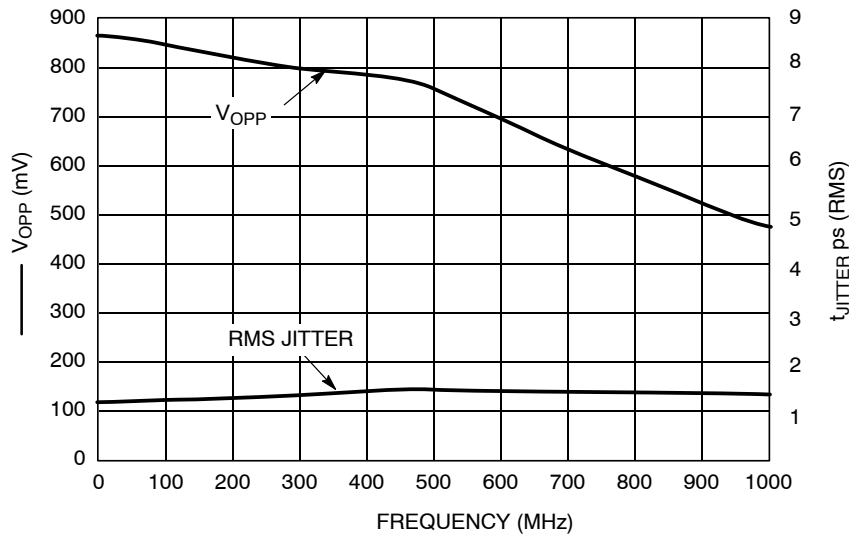

**Figure 3. Output Frequency ( $F_{OUT}$ ) versus Output Voltage ( $V_{OPP}$ ) and Random Clock Jitter ( $t_{JITTER}$ )**

# MC100EP809

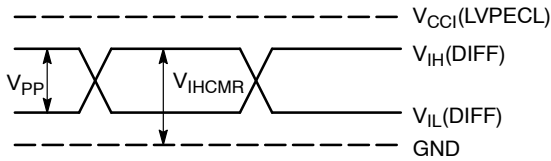

Figure 4. LVPECL Differential Input Levels

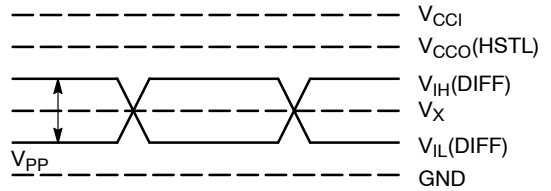

Figure 5. HSTL Differential Input Levels

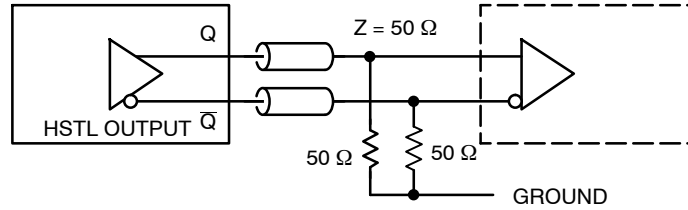
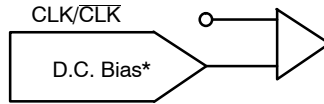

Figure 6. HSTL Output Termination and AC Test Reference



\*Must be CLK/CLK-bar common mode voltage:  $(V_{IH} + V_{IL})/2$ .

Figure 7. Single-Ended CLK/CLK-bar Input Configuration

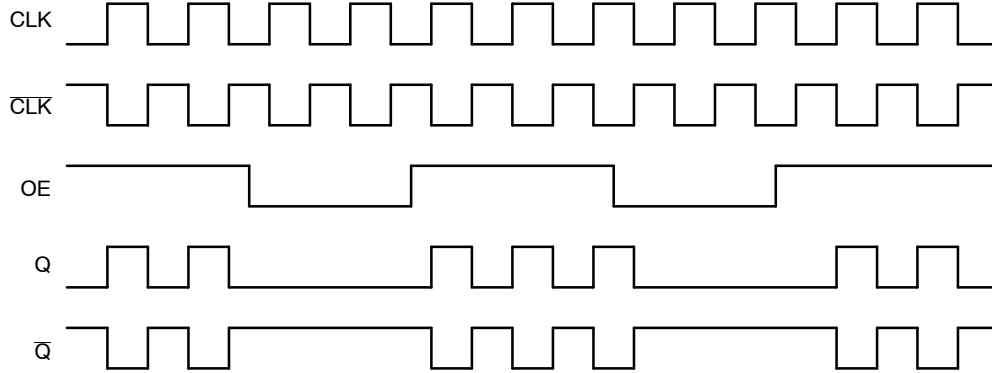

Figure 8. Output Enable (OE) Timing Diagram

## Resource Reference of Application Notes

- AN1405/D** – ECL Clock Distribution Techniques
- AN1406/D** – Designing with PECL (ECL at +5.0 V)
- AN1503/D** – ECLinPS™ I/O SPiCE Modeling Kit
- AN1504/D** – Metastability and the ECLinPS Family
- AN1568/D** – Interfacing Between LVDS and ECL
- AN1672/D** – The ECL Translator Guide
- AND8001/D** – Odd Number Counters Design
- AND8002/D** – Marking and Date Codes
- AND8020/D** – Termination of ECL Logic Devices
- AND8066/D** – Interfacing with ECLinPS
- AND8090/D** – AC Characteristics of ECL Devices

# MECHANICAL CASE OUTLINE

## PACKAGE DIMENSIONS

ON Semiconductor®

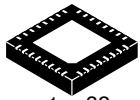

1 32

SCALE 2:1

QFN32 5x5, 0.5P  
CASE 488AM  
ISSUE A

DATE 23 OCT 2013

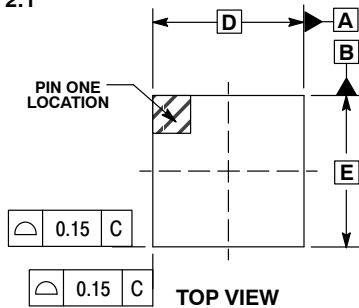

TOP VIEW

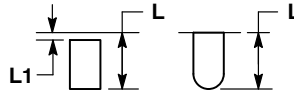

DETAIL A  
ALTERNATE TERMINAL  
CONSTRUCTIONS

NOTES:

1. DIMENSIONS AND TOLERANCING PER ASME Y14.5M, 1994.
2. CONTROLLING DIMENSION: MILLIMETERS.
3. DIMENSION b APPLIES TO PLATED TERMINAL AND IS MEASURED BETWEEN 0.15 AND 0.30MM FROM THE TERMINAL TIP. COPLANARITY APPLIES TO THE EXPOSED PAD AS WELL AS THE TERMINALS.
4. COPLANARITY APPLIES TO THE EXPOSED PAD AS WELL AS THE TERMINALS.

MILLIMETERS		
DIM	MIN	MAX
A	0.80	1.00
A1	---	0.05
A3	0.20	REF
b	0.18	0.30
D	5.00	BSC
D2	2.95	3.25
E	5.00	BSC
E2	2.95	3.25
e	0.50	BSC
K	0.20	---
L	0.30	0.50
L1	---	0.15

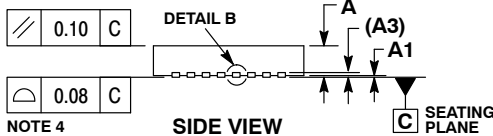

SIDE VIEW

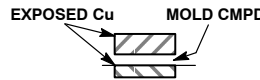

DETAIL B  
ALTERNATE  
CONSTRUCTION

GENERIC  
MARKING DIAGRAM\*

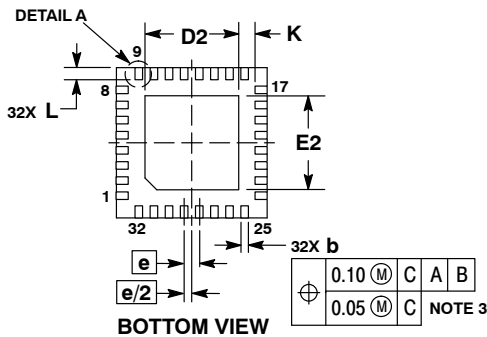

BOTTOM VIEW

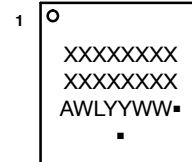

- XXXXX = Specific Device Code
- A = Assembly Location
- WL = Wafer Lot
- YY = Year
- WW = Work Week
- = Pb-Free Package

(Note: Microdot may be in either location)

\*This information is generic. Please refer to device data sheet for actual part marking.

Pb-Free indicator, "G" or microdot "▪", may or may not be present.

RECOMMENDED  
SOLDERING FOOTPRINT\*

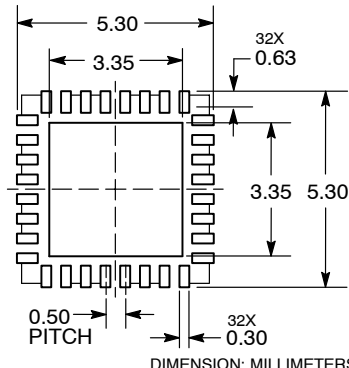

DIMENSION: MILLIMETERS

\*For additional information on our Pb-Free strategy and soldering details, please download the ON Semiconductor Soldering and Mounting Techniques Reference Manual, SOLDERRM/D.

DOCUMENT NUMBER:	98AON20032D	Electronic versions are uncontrolled except when accessed directly from the Document Repository. Printed versions are uncontrolled except when stamped "CONTROLLED COPY" in red.
DESCRIPTION:	QFN32 5x5 0.5P	PAGE 1 OF 1

ON Semiconductor and ON are trademarks of Semiconductor Components Industries, LLC dba ON Semiconductor or its subsidiaries in the United States and/or other countries. ON Semiconductor reserves the right to make changes without further notice to any products herein. ON Semiconductor makes no warranty, representation or guarantee regarding the suitability of its products for any particular purpose, nor does ON Semiconductor assume any liability arising out of the application or use of any product or circuit, and specifically disclaims any and all liability, including without limitation special, consequential or incidental damages. ON Semiconductor does not convey any license under its patent rights nor the rights of others.



**onsemi**, **Onsemi**, and other names, marks, and brands are registered and/or common law trademarks of Semiconductor Components Industries, LLC dba "**onsemi**" or its affiliates and/or subsidiaries in the United States and/or other countries. **onsemi** owns the rights to a number of patents, trademarks, copyrights, trade secrets, and other intellectual property. A listing of **onsemi**'s product/patent coverage may be accessed at [www.onsemi.com/site/pdf/Patent-Marking.pdf](http://www.onsemi.com/site/pdf/Patent-Marking.pdf). **onsemi** reserves the right to make changes at any time to any products or information herein, without notice. The information herein is provided "as-is" and **onsemi** makes no warranty, representation or guarantee regarding the accuracy of the information, product features, availability, functionality, or suitability of its products for any particular purpose, nor does **onsemi** assume any liability arising out of the application or use of any product or circuit, and specifically disclaims any and all liability, including without limitation special, consequential or incidental damages. Buyer is responsible for its products and applications using **onsemi** products, including compliance with all laws, regulations and safety requirements or standards, regardless of any support or applications information provided by **onsemi**. "Typical" parameters which may be provided in **onsemi** data sheets and/or specifications can and do vary in different applications and actual performance may vary over time. All operating parameters, including "Typicals" must be validated for each customer application by customer's technical experts. **onsemi** does not convey any license under any of its intellectual property rights nor the rights of others. **onsemi** products are not designed, intended, or authorized for use as a critical component in life support systems or any FDA Class 3 medical devices or medical devices with a same or similar classification in a foreign jurisdiction or any devices intended for implantation in the human body. Should Buyer purchase or use **onsemi** products for any such unintended or unauthorized application, Buyer shall indemnify and hold **onsemi** and its officers, employees, subsidiaries, affiliates, and distributors harmless against all claims, costs, damages, and expenses, and reasonable attorney fees arising out of, directly or indirectly, any claim of personal injury or death associated with such unintended or unauthorized use, even if such claim alleges that **onsemi** was negligent regarding the design or manufacture of the part. **onsemi** is an Equal Opportunity/Affirmative Action Employer. This literature is subject to all applicable copyright laws and is not for resale in any manner.

## ADDITIONAL INFORMATION

### TECHNICAL PUBLICATIONS:

Technical Library: [www.onsemi.com/design/resources/technical-documentation](http://www.onsemi.com/design/resources/technical-documentation)  
onsemi Website: [www.onsemi.com](http://www.onsemi.com)

### ONLINE SUPPORT: [www.onsemi.com/support](http://www.onsemi.com/support)

For additional information, please contact your local Sales Representative at [www.onsemi.com/support/sales](http://www.onsemi.com/support/sales)