

# NCV7601

## Quad Driver

This automotive grade product provides a versatile interface between control logic and many types of loads. The inputs accept a wide range of control signal levels while the open-collector outputs feature independent thermal and current limiting. Integral transient suppression diodes are provided at all inputs and outputs.

### Features

- Operation in  $-40^{\circ}\text{C}$  -  $125^{\circ}\text{C}$  Environment
- TTL/DTL/CMOS Compatible Inputs
- NAND Logic with Common Enable
- $V_{\text{CEX}} \geq 60\text{ V}$ ,  $V_{\text{CE(SUS)}} \geq 40\text{ V}$
- $V_{\text{CE(SAT)}} \leq 650\text{ mV}$  @  $I_{\text{C}} = 600\text{ mA}$
- Thermally Efficient Fused-Lead Package
- Pin Compatible with:
  - CA3242/CA3262
  - UDx2543/UDx2549/UDx2559
  - L6220/L6221/L9222
- AEC Qualified
- PPAP Capable
- Pb-Free Package is Available\*

### Typical Applications

- Body and Drivetrain Electronics
- Incandescent Lamp/LED Loads
- Solenoid/Relay/Inductor Loads
- Heater/Resistor Loads
- Stepper/DC Motor Loads

### ABSOLUTE MAXIMUM RATINGS

Rating	Value	Unit
$V_{\text{CC}}$	-0.3 to 7.0	V
Logic Input Voltage (INA, INB, INC, IND, ENABLE)	-0.3 to 15	V
Power Output (OUTA, OUTB, OUTC, OUTD)	-0.3 to 60	V
Junction Temperature Range, $T_{\text{J}}$	-40 to 150	$^{\circ}\text{C}$
Storage Temperature Range	-55 to 150	$^{\circ}\text{C}$
ESD Susceptibility (Human Body Model)	2.0	kV
Package Thermal Resistance Junction-to-Case, $R_{\theta\text{JC}}$ Junction-to-Ambient, $R_{\theta\text{JA}}$	15 50	$^{\circ}\text{C}/\text{W}$ $^{\circ}\text{C}/\text{W}$
Lead Temperature Soldering: Wave Solder (through hole styles only) (Note 1)	260 peak	$^{\circ}\text{C}$

Stresses exceeding Maximum Ratings may damage the device. Maximum Ratings are stress ratings only. Functional operation above the Recommended Operating Conditions is not implied. Extended exposure to stresses above the Recommended Operating Conditions may affect device reliability.

1. 10 second maximum.

\*For additional information on our Pb-Free strategy and soldering details, please download the ON Semiconductor Soldering and Mounting Techniques Reference Manual, SOLDERRM/D.



ON Semiconductor®

<http://onsemi.com>

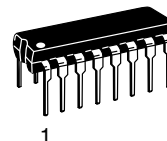

PDIP-16  
P SUFFIX  
CASE 648

### MARKING DIAGRAM



A = Assembly Location  
WL = Wafer Lot  
YY = Year  
WW = Work Week  
G = Pb-Free Package

### PIN CONNECTIONS

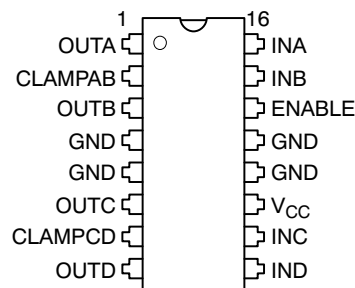

### ORDERING INFORMATION

Device	Package	Shipping
NCV7601P	PDIP-16	25 Units/Rail
NCV7601PG	PDIP-16 (Pb-Free)	25 Units/Rail

# NCV7601

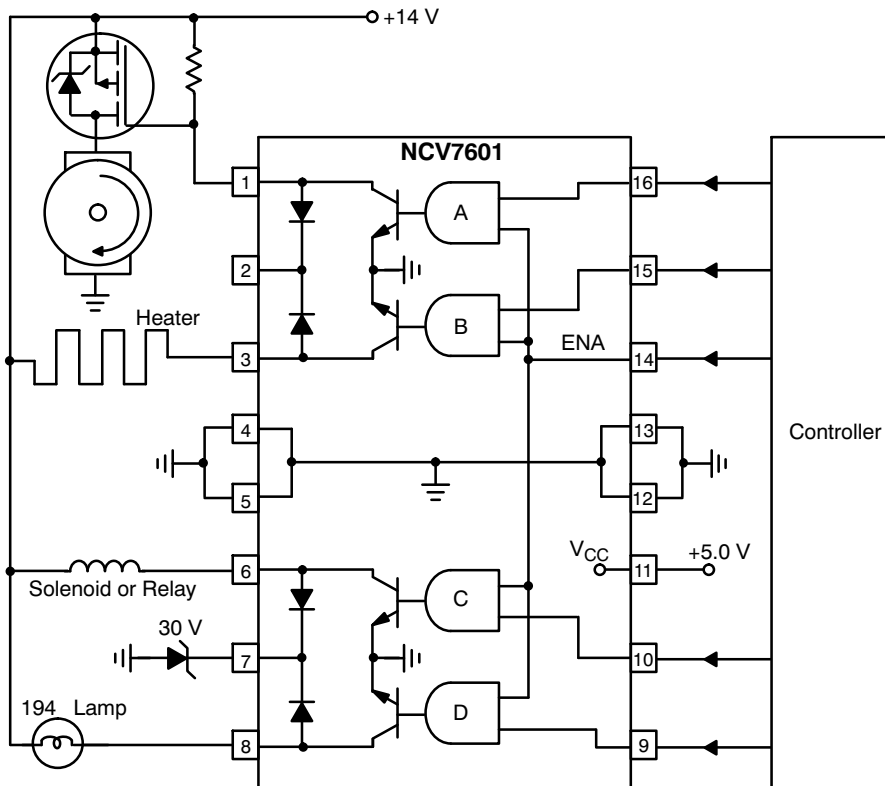

Figure 1. Typical Driver Applications

## ELECTRICAL CHARACTERISTICS (4.0 V ≤ V<sub>CC</sub> ≤ 5.5 V, -40°C ≤ T<sub>J</sub> ≤ 125°C, unless otherwise specified.) Note 2

Characteristic	Test Conditions	Min	Typ	Max	Unit
<b>GENERAL</b>					
V <sub>CC</sub> Supply Current	Outputs Off, V <sub>CC</sub> = 5.5 V Note 3 I <sub>OUT</sub> = 600 mA, V <sub>CC</sub> = V <sub>IN</sub> = 5.5 V (four outputs on) (one output on)	-	-	5.0	mA
		-	-	65	mA
		-	-	20	mA
<b>OUTPUT DRIVERS</b>					
Saturation Voltage	I <sub>OUT</sub> = 600 mA, V <sub>IN</sub> = 2.0 V, V <sub>CC</sub> = 4.0 V	-	-	650	mV
Leakage Current	V <sub>OUT</sub> = 60 V, V <sub>IN</sub> = 0.8 V, V <sub>CC</sub> = 5.5 V	-	-	50	μA
Current Limit	4.5 V < V <sub>OUT</sub> < 16 V, V <sub>CC</sub> = 5.0 V	-	-	1.8	A
Thermal Shutdown	-	150	180	210	°C
Sustaining Voltage, V <sub>CE(SUS)</sub>	V <sub>CC</sub> = 5.5 V	40	-	-	V
<b>CLAMP DIODES</b>					
Forward Voltage	I <sub>F</sub> = 1.5 A, V <sub>CC</sub> = 5.5 V	-	-	2.0	V
Leakage Current	V <sub>R</sub> = 60 V, V <sub>CC</sub> = 5.5 V	-	-	100	μA
<b>INPUT</b>					
Input Current	0 V ≤ V <sub>IN</sub> ≤ V <sub>CC</sub>	-2.0	-	10	μA
Input High Voltage	I <sub>OUT</sub> = 600 mA	2.0	-	-	V
Input Low Voltage	I <sub>OUT</sub> = 600 mA	-	-	0.8	V
<b>AC CHARACTERISTICS (Note 4)</b>					
Turn-On Delay, Turn-Off Delay	I <sub>OUT</sub> = 500 mA	-	-	10	μs

2. Designed to meet these characteristics over the stated temperature range, though may not be 100% parametrically tested in production.

3. Pulse test.

4. Input rise time ≤ 10 ns, falltime ≤ 10 ns, measured at 50% points.

# NCV7601

## PACKAGE PIN DESCRIPTION

PACKAGE PIN #	PIN SYMBOL	FUNCTION
1	OUTA	Driver A Output
2	CLAMPAB	Diode Clamp to Driver A and Driver B
3	OUTB	Driver B Output
4	GND	Ground
5	GND	Ground
6	OUTC	Driver C Output
7	CLAMPAB	Diode Clamp to Driver C and Driver D
8	OUTD	Driver D Output
9	IND	Driver D Input
10	INC	Driver C Input
11	V <sub>CC</sub>	5.0 V Input Supply Voltage
12	GND	Ground
13	GND	Ground
14	ENABLE	ENABLE Input to all Drivers
15	INB	Driver B Input
16	INA	Driver A Input

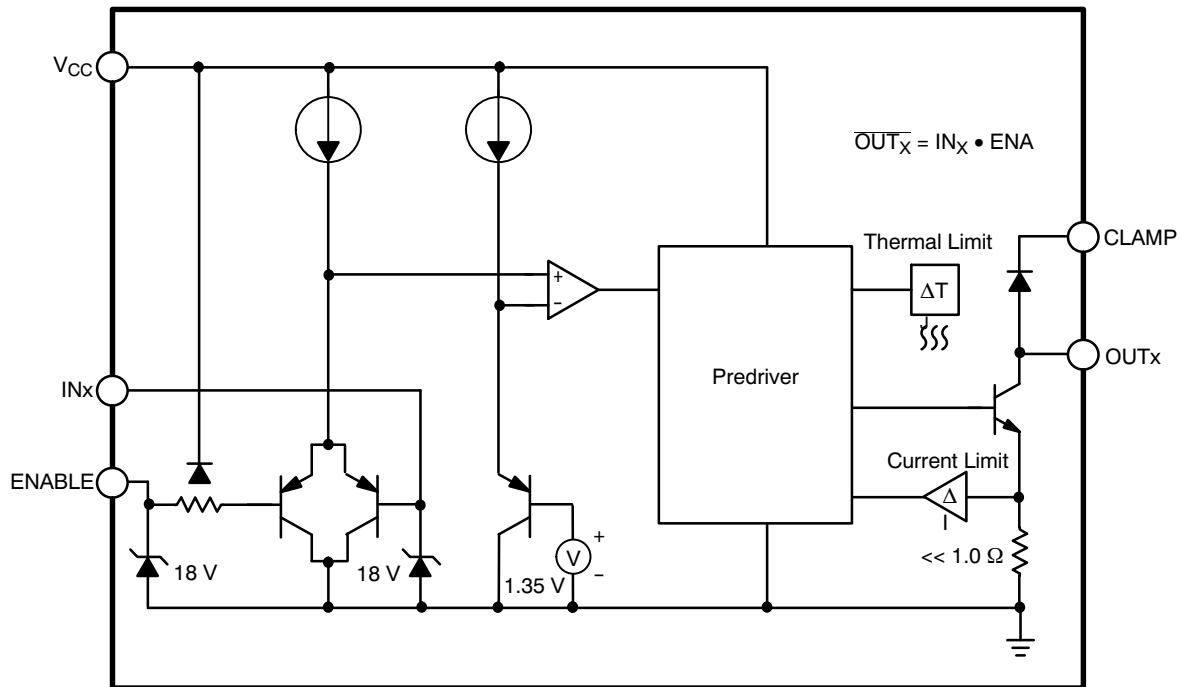

Figure 2. Simplified Block Diagram - Each Driver

TYPICAL PERFORMANCE CHARACTERISTICS

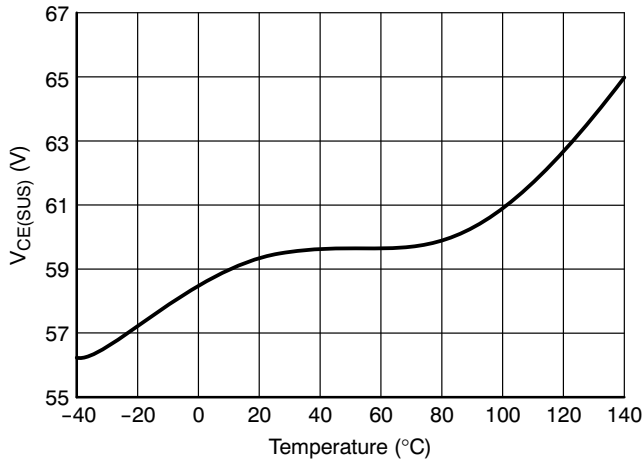

Figure 3. Typical  $V_{CE(sus)}$

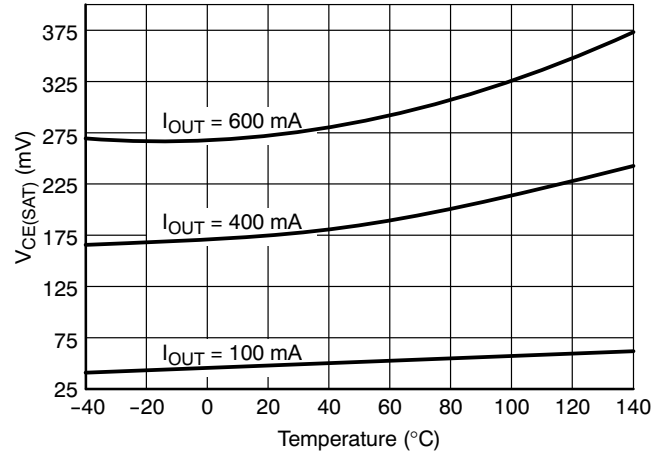

Figure 4. Typical Output On Voltage,  $V_{CC} = 4.0 V$

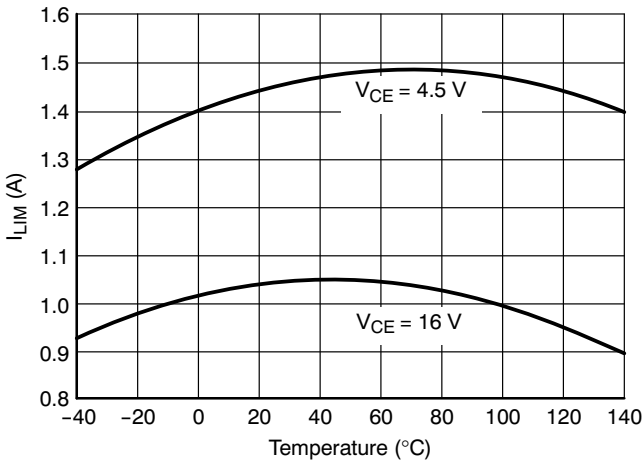

Figure 5. Typical Output Current Limit,  $V_{CC} = 5.0 V$

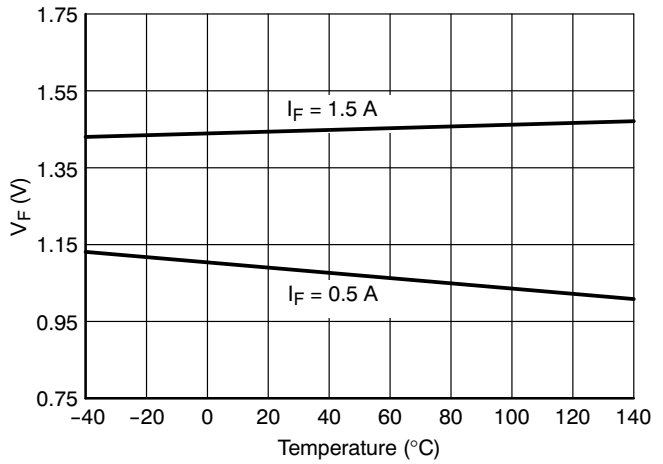

Figure 6. Typical Clamp Diode Forward Voltage

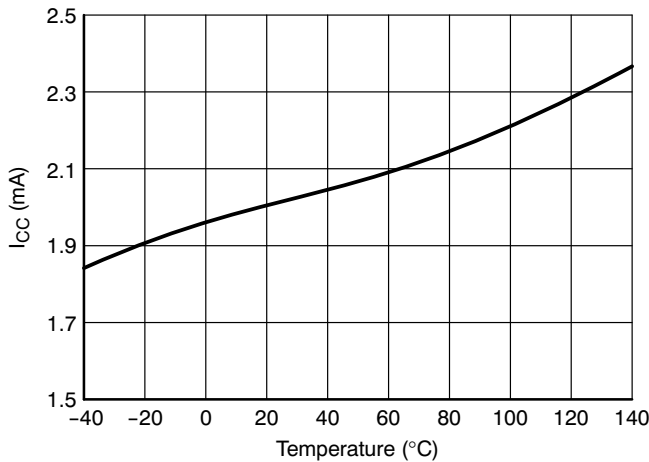

Figure 7. Typical  $V_{CC}$  Current - No Outputs On,  $V_{CC} = 5.5 V$

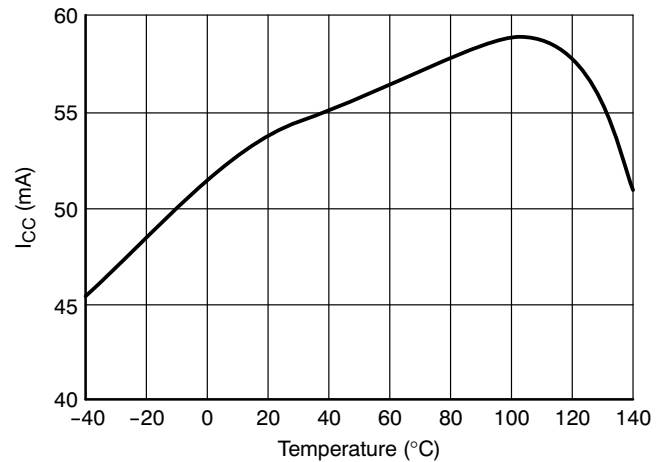

Figure 8. Typical  $V_{CC}$  Current - All Outputs On,  $V_{CC} = 5.5 V$ ,  $I_{OUT} = 600 mA$  (Each Output)

TYPICAL PERFORMANCE CHARACTERISTICS

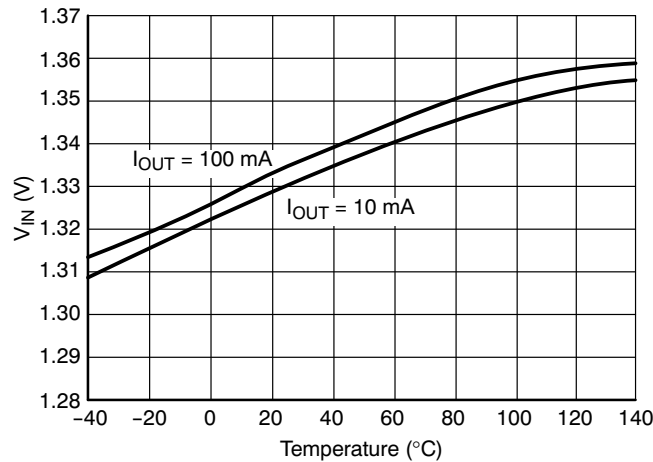

Figure 9. Typical Input Threshold Voltage, V<sub>CC</sub> = 5.0 V

DETAILED OPERATING DESCRIPTION

The NCV7601 Quad Driver consists of four identical driver sections with output clamp diodes and a common bias generator.

Each driver input (Figure 2) is buffered by a PNP emitter follower for reduced input bias current and features a nominal 18 V Zener input clamp for transient protection. Each input is compared to a separate temperature-compensated reference, which provides a nominal 1.35 V comparison threshold. With the addition of an external series resistor, the inputs can be interfaced directly to +14 V automotive system voltages. Floating inputs are interpreted as high.

Each driver output NPN is supplied with a substantially fixed base current from the +5.0 V V<sub>CC</sub> pin by a pre-driver.

Each pre-driver multiplies a temperature-compensated reference current when its control input and the common enable input is high. Current limit and thermal limit circuits act independently within the pre-driver to reduce base drive to the output NPN. The independent limit operation allows the driver to handle inrush current from lamp loads while protecting the driver from fault conditions that exist long enough to raise the temperature at that driver to its thermal limit threshold. Each driver has its own temperature-sensing device located in close proximity to the output NPN. The separate sensing devices are strategically placed at the corners of the die to reduce interaction between them.

APPLICATIONS INFORMATION

The NCV7601 Quad Driver interfaces high power loads to low power control signals. The four open-collector NAND drivers with common ENABLE are TTL, DTL and CMOS compatible. Any number of drivers may be parallel connected to drive loads greater than each driver’s nominal capability. Power for the Quad’s control logic and output pre-drive is supplied from the +5.0 V V<sub>CC</sub> pin, and is proportional to the number of active inputs. Minimum standby power is consumed when the ENABLE input is low. Each driver is individually protected with current limit and thermal limit circuitry. Drivers with fault loads are protected while drivers with normal loads continue to operate, provided that sufficient heat sinking maintains a good thermal gradient between all drivers.

Clamp diodes at each driver output provide a means for managing inductive load transients. The common cathode pin for each driver pair can be connected to the load supply voltage for suppression of minor transients resulting from

wiring harness inductances. The use of an external Zener diode or TVS (Transient Voltage Suppressor) device such as the ON Semiconductor 1.5SMCXXXAT3 series is strongly recommended when driving large inductive loads or when load supply transients can be expected to exceed the Quad Driver’s VCE(SUS) rating. The use of a TVS device provides an additional benefit by reducing the decay time of inductive loads. More information on safeguarding the Quad’s output NPN’s and about transient suppression methods and device selection is available in ON Semiconductor application notes “Understanding Power Transistors Breakdown Parameters”, document number AN1628/D, “A Review of Transients and their Means Of Suppression”, document number AN843/D and “Transient Power Capability of Zener Diodes”, document number AN784/D. All application notes are available through the Literature Distribution Center or via our website at <http://www.onsemi.com>.

# MECHANICAL CASE OUTLINE PACKAGE DIMENSIONS

ON Semiconductor®



SCALE 1:1

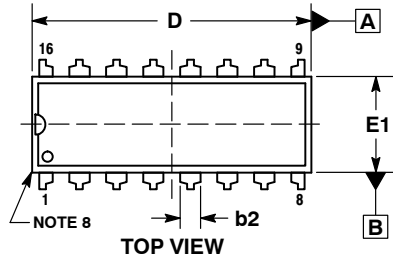

TOP VIEW

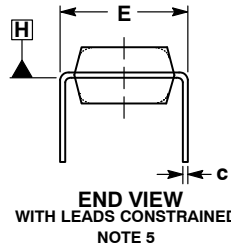

END VIEW  
WITH LEADS CONSTRAINED  
NOTE 5

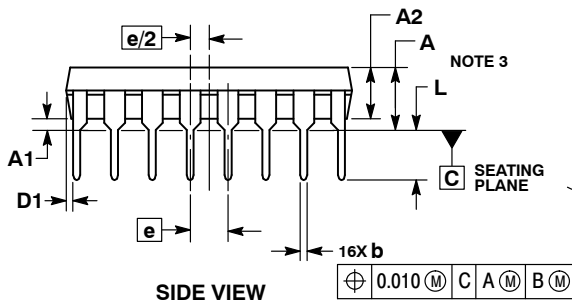

SIDE VIEW

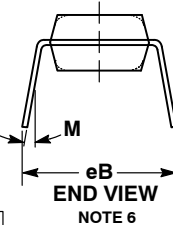

END VIEW  
NOTE 6

## PDIP-16 CASE 648-08 ISSUE V

DATE 22 APR 2015

NOTES:

- DIMENSIONING AND TOLERANCING PER ASME Y14.5M, 1994.
- CONTROLLING DIMENSION: INCHES.
- DIMENSIONS A, A1 AND L ARE MEASURED WITH THE PACKAGE SEATED IN JEDEC SEATING PLANE GAUGE GS-3.
- DIMENSIONS D, D1 AND E1 DO NOT INCLUDE MOLD FLASH OR PROTRUSIONS. MOLD FLASH OR PROTRUSIONS ARE NOT TO EXCEED 0.10 INCH.
- DIMENSION E IS MEASURED AT A POINT 0.015 BELOW DATUM PLANE H WITH THE LEADS CONSTRAINED PERPENDICULAR TO DATUM C.
- DIMENSION eB IS MEASURED AT THE LEAD TIPS WITH THE LEADS UNCONSTRAINED.
- DATUM PLANE H IS COINCIDENT WITH THE BOTTOM OF THE LEADS, WHERE THE LEADS EXIT THE BODY.
- PACKAGE CONTOUR IS OPTIONAL (ROUNDED OR SQUARE CORNERS).

DIM	INCHES		MILLIMETERS	
	MIN	MAX	MIN	MAX
A	---	0.210	---	5.33
A1	0.015	---	0.38	---
A2	0.115	0.195	2.92	4.95
b	0.014	0.022	0.35	0.56
b2	0.060 TYP		1.52 TYP	
C	0.008	0.014	0.20	0.36
D	0.735	0.775	18.67	19.69
D1	0.005	---	0.13	---
E	0.300	0.325	7.62	8.26
E1	0.240	0.280	6.10	7.11
e	0.100 BSC		2.54 BSC	
eB	---	0.430	---	10.92
L	0.115	0.150	2.92	3.81
M	---	10°	---	10°

### GENERIC MARKING DIAGRAM\*

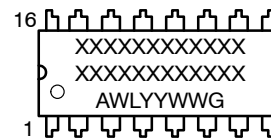

- XXXXX = Specific Device Code
- A = Assembly Location
- WL = Wafer Lot
- YY = Year
- WW = Work Week
- G = Pb-Free Package

STYLE 1:

- PIN 1. CATHODE
- 2. CATHODE
- 3. CATHODE
- 4. CATHODE
- 5. CATHODE
- 6. CATHODE
- 7. CATHODE
- 8. CATHODE
- 9. ANODE
- 10. ANODE
- 11. ANODE
- 12. ANODE
- 13. ANODE
- 14. ANODE
- 15. ANODE
- 16. ANODE

STYLE 2:

- PIN 1. COMMON DRAIN
- 2. COMMON DRAIN
- 3. COMMON DRAIN
- 4. COMMON DRAIN
- 5. COMMON DRAIN
- 6. COMMON DRAIN
- 7. COMMON DRAIN
- 8. COMMON DRAIN
- 9. GATE
- 10. SOURCE
- 11. GATE
- 12. SOURCE
- 13. GATE
- 14. SOURCE
- 15. GATE
- 16. SOURCE

\*This information is generic. Please refer to device data sheet for actual part marking. Pb-Free indicator, "G" or microdot "▪", may or may not be present.

DOCUMENT NUMBER:	98ASB42431B	Electronic versions are uncontrolled except when accessed directly from the Document Repository. Printed versions are uncontrolled except when stamped "CONTROLLED COPY" in red.
DESCRIPTION:	PDIP-16	PAGE 1 OF 1

ON Semiconductor and ON are trademarks of Semiconductor Components Industries, LLC dba ON Semiconductor or its subsidiaries in the United States and/or other countries. ON Semiconductor reserves the right to make changes without further notice to any products herein. ON Semiconductor makes no warranty, representation or guarantee regarding the suitability of its products for any particular purpose, nor does ON Semiconductor assume any liability arising out of the application or use of any product or circuit, and specifically disclaims any and all liability, including without limitation special, consequential or incidental damages. ON Semiconductor does not convey any license under its patent rights nor the rights of others.

**onsemi**, **Onsemi**, and other names, marks, and brands are registered and/or common law trademarks of Semiconductor Components Industries, LLC dba "**onsemi**" or its affiliates and/or subsidiaries in the United States and/or other countries. **onsemi** owns the rights to a number of patents, trademarks, copyrights, trade secrets, and other intellectual property. A listing of **onsemi**'s product/patent coverage may be accessed at [www.onsemi.com/site/pdf/Patent-Marking.pdf](http://www.onsemi.com/site/pdf/Patent-Marking.pdf). **onsemi** reserves the right to make changes at any time to any products or information herein, without notice. The information herein is provided "as-is" and **onsemi** makes no warranty, representation or guarantee regarding the accuracy of the information, product features, availability, functionality, or suitability of its products for any particular purpose, nor does **onsemi** assume any liability arising out of the application or use of any product or circuit, and specifically disclaims any and all liability, including without limitation special, consequential or incidental damages. Buyer is responsible for its products and applications using **onsemi** products, including compliance with all laws, regulations and safety requirements or standards, regardless of any support or applications information provided by **onsemi**. "Typical" parameters which may be provided in **onsemi** data sheets and/or specifications can and do vary in different applications and actual performance may vary over time. All operating parameters, including "Typicals" must be validated for each customer application by customer's technical experts. **onsemi** does not convey any license under any of its intellectual property rights nor the rights of others. **onsemi** products are not designed, intended, or authorized for use as a critical component in life support systems or any FDA Class 3 medical devices or medical devices with a same or similar classification in a foreign jurisdiction or any devices intended for implantation in the human body. Should Buyer purchase or use **onsemi** products for any such unintended or unauthorized application, Buyer shall indemnify and hold **onsemi** and its officers, employees, subsidiaries, affiliates, and distributors harmless against all claims, costs, damages, and expenses, and reasonable attorney fees arising out of, directly or indirectly, any claim of personal injury or death associated with such unintended or unauthorized use, even if such claim alleges that **onsemi** was negligent regarding the design or manufacture of the part. **onsemi** is an Equal Opportunity/Affirmative Action Employer. This literature is subject to all applicable copyright laws and is not for resale in any manner.

## ADDITIONAL INFORMATION

### TECHNICAL PUBLICATIONS:

Technical Library: [www.onsemi.com/design/resources/technical-documentation](http://www.onsemi.com/design/resources/technical-documentation)  
onsemi Website: [www.onsemi.com](http://www.onsemi.com)

### ONLINE SUPPORT: [www.onsemi.com/support](http://www.onsemi.com/support)

For additional information, please contact your local Sales Representative at [www.onsemi.com/support/sales](http://www.onsemi.com/support/sales)