

# Silicon Carbide (SiC) Module – EliteSiC Power Module for Traction Inverter, Single-Side Cooling, 2.6 mohm, 1200 V, Half-Bridge, 90° Power Tabs

## NVVR26A120M1WST

### Product Description

The NVVR26A120M1WST is part of the EliteSiC power module for traction inverter, a revolutionary high mobility compound semiconductor product family that offers increased performance, better efficiency, and higher power density in similar and highly compatible packaging solutions. The module integrates 1200 V SiC MOSFET in a half-bridge configuration. To enhance reliability and thermal performance, sintering technology is applied for die attach. The module is designed to meet the AQG324 standard.

### Features

- Ultra Low  $R_{DS(on)}$
- Aluminum Nitride Isolator
- Ultra-low Stray Inductance ~ 7.1 nH
- $T_{vj,Max} = 175^{\circ}C$  for Continuous Operation
- Automotive Grade SiC MOSFET Chip Technologies
- Sintered Die Technology for High Reliability Performance
- Automotive Module AQG324 Compliant
- PPAP Capable

### Applications

- Automotive EV/HEV– Traction Inverter

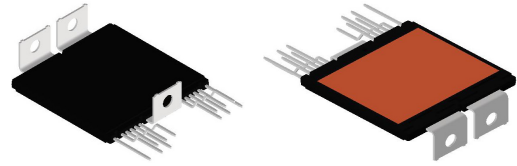

AHPM15-CDA MODULE  
 CASE MODHG

### MARKING DIAGRAM

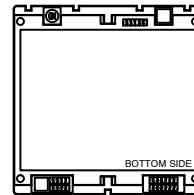

ZZZ ATYWW	K2R261T NNNNNNN
--------------	--------------------

ZZZ = Assembly Lot Code  
 K2R261T = Marking Value  
 AT = Assembly & Test Location  
 Y = Year  
 WW = Work Week  
 NNNN = Serial Number

### PIN CONFIGURATION

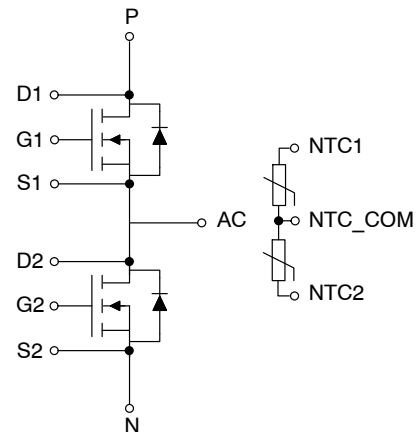

### ORDERING INFORMATION

Device	Package	Shipping
NVVR26A120M1WST	A1HPM	Tube

# NVVR26A120M1WST

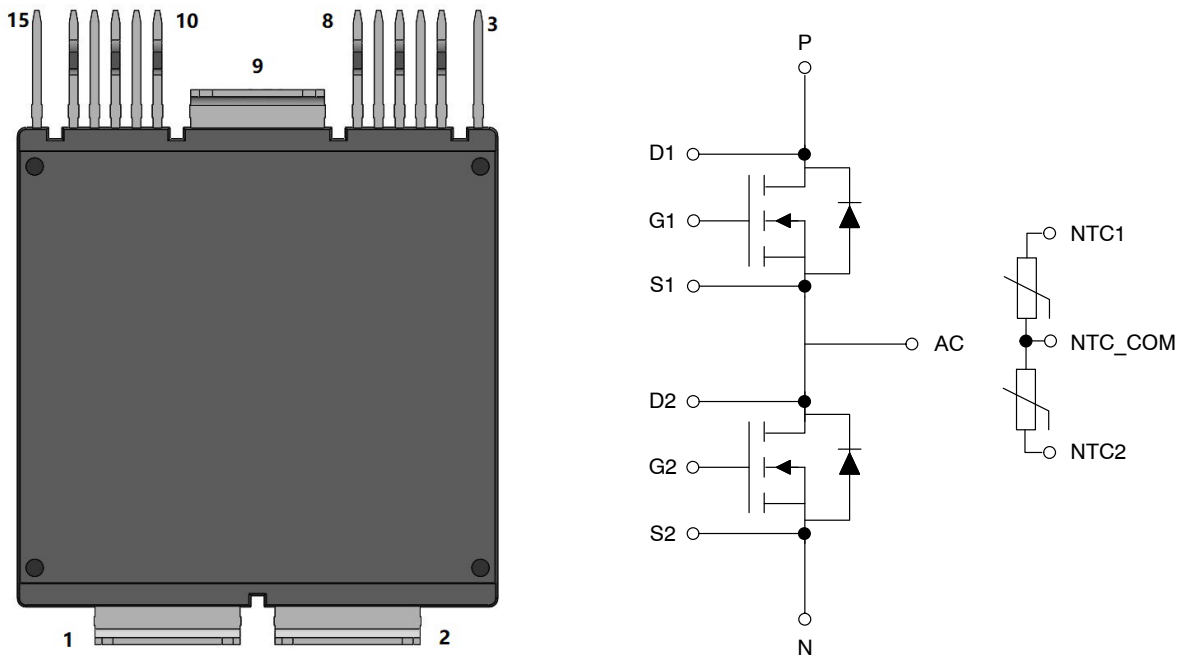

Figure 1. Pin Description

## PIN FUNCTION DESCRIPTIONS

Pin No.	Pin Name	Pin Functional Description
1	N	Negative Power Terminal
2	P	Positive Power Terminal
3	D1	High Side MOSFET (Q1) Drain Sense
4	N/C	No Connection
5	S1	High Side MOSFET (Q1) Source
6	G1	High Side MOSFET (Q1) Gate
7	N/C	No Connection
8	N/C	No Connection
9	AC	Phase Output
10	NTC1	NTC 1
11	S2	Low Side MOSFET (Q2) Source
12	G2	Low Side MOSFET (Q2) Gate
13	NTC2	NTC 2
14	NTC_COM	NTC common
15	D2	Low Side MOSFET (Q2) Drain Sense

### Materials

DBC Substrate: AIN isolated substrate, basic isolation, and copper on both sides

Lead frame: Copper, with tin electro-plating

### Flammability Information

All materials present in the power module meet UL flammability rating class 94V-0

# NVVR26A120M1WST

## MODULE CHARACTERISTICS ( $T_{vj} = 25^{\circ}\text{C}$ , Unless Otherwise Specified)

Symbol	Parameter	Rating	Unit
$T_{vj}$	Operating Junction Temperature	-40 to 175	$^{\circ}\text{C}$
$T_{STG}$	Storage Temperature Range	-40 to 125	$^{\circ}\text{C}$
$V_{ISO}$	Isolation Voltage (AC, 50 Hz, 5 s)	4200	V
$L_{SDS}$	Stray Inductance	7.1	nH
$R_{DD+SS}$	Module Lead Resistance, Terminal to Chip	0.3	$\text{m}\Omega$
G	Module Weight	48	g
CTI	Comparative Tracking Index	>600	-
Creepage	Minimum: Terminal to Terminal	5.0	mm
Clearance	Minimum: (Note 1) Terminal to Terminal	3.2	mm
M	M5 DIN 439B Screws for Module Terminals, Max. Torque	2.2	Nm

1. Verified by design/characterization, not tested.

## ABSOLUTE MAXIMUM RATINGS ( $T_{vj} = 25^{\circ}\text{C}$ , Unless Otherwise Specified)

Symbol	Parameter	Rating	Unit
$V_{DS}$	Drain-Source Voltage	1200	V
$V_{GS}$	Gate-Source Voltage	+25/-10	V
$I_{DS}$	Continuous DC Current, $V_{GS} = 20\text{ V}$ , $T_{vj} = 175^{\circ}\text{C}$ , $T_F = 65^{\circ}\text{C}$ @ 10LPM, using Ref. Heatsink (Note 2)	400	A
$I_{DS,pulsed}$	Pulsed Drain-Source Current, $V_{GS} = 20\text{ V}$ , limited by $T_{vj,Max}$	800	A
$I_{SD,BD}$	DC Current in Body Diode, $V_{GS} = -5\text{ V}$ , $T_{vj} = 175^{\circ}\text{C}$ , $T_F = 65^{\circ}\text{C}$ @ 10LPM, using Ref. Heatsink (Note 2)	270	A
$I_{SD,pulsed}$	Pulsed Body Diode Current, $V_{GS} = -5\text{ V}$ , limited by $T_{vj,Max}$	800	A
$P_{tot}$	Total Power Dissipation $T_{vj,Max} = 175^{\circ}\text{C}$ , $T_F = 65^{\circ}\text{C}$ , Ref. Heatsink (typ)	1000	W

Stresses exceeding those listed in the Maximum Ratings table may damage the device. If any of these limits are exceeded, device functionality should not be assumed, damage may occur and reliability may be affected.

2. Verified by design / not by test.

# NVVR26A120M1WST

## MOSFET CHARACTERISTICS (T<sub>vj</sub> = 25°C, Unless Otherwise Specified)

Parameter		Conditions		Min	Typ	Max	Unit
R <sub>DS(ON)</sub>	Drain-to-Source On Resistance (Terminal)	V <sub>GS</sub> = 20V, I <sub>D</sub> = 400A T <sub>vj</sub> = 25°C T <sub>vj</sub> = 175°C		-	2.6 4.6	-	mΩ
V <sub>GS(TH)</sub>	Gate Threshold Voltage	V <sub>GS</sub> = V <sub>DS</sub> , I <sub>D</sub> = 150 mA		2.1	3.2	-	V
g <sub>fs</sub>	Forward Transconductance	V <sub>DS</sub> = 10 V, I <sub>D</sub> = 400 A		-	170	-	S
Q <sub>G</sub>	Total Gate Charge	V <sub>GS</sub> = -5/+20 V, V <sub>DS</sub> = 800 V, I <sub>D</sub> = 400 A		-	1.75	-	μC
R <sub>g,int</sub>	Internal Gate Resistance			-	2.1	-	Ω
C <sub>iss</sub>	Input Capacitance	V <sub>DS</sub> = 800 V, V <sub>GS</sub> = 0 V, f = 100 kHz		-	31.7	-	nF
C <sub>oss</sub>	Output Capacitance			-	2.2	-	nF
C <sub>rss</sub>	Reverse Transfer Capacitance			-	0.22	-	nF
I <sub>DSS</sub>	Zero Gate Voltage Drain Current	V <sub>GS</sub> = 0 V, V <sub>DS</sub> = 1200 V T <sub>vj</sub> = 25°C T <sub>vj</sub> = 175°C		-	- 13.1	250 -	μA
I <sub>GSS</sub>	Gate-Source Leakage Current	V <sub>GS</sub> = 20/-5 V, V <sub>DS</sub> = 0 V				±700	nA
T <sub>d,on</sub>	Turn On Delay, Inductive Load	I <sub>DS</sub> = 400 A, V <sub>DS</sub> = 800 V, V <sub>GS</sub> = +20/-5 V, R <sub>g,on</sub> = 3 Ω	T <sub>vj</sub> = 25°C T <sub>vj</sub> = 175°C	-	125 115	-	ns
T <sub>r</sub>	Rise Time, Inductive Load	I <sub>DS</sub> = 400 A, V <sub>DS</sub> = 800 V, V <sub>GS</sub> = +20/-5 V, R <sub>g,on</sub> = 3Ω	T <sub>vj</sub> = 25°C T <sub>vj</sub> = 175°C	-	59 54	-	ns
T <sub>d,off</sub>	Turn Off Delay, Inductive Load	I <sub>DS</sub> = 400 A, V <sub>DS</sub> = 800 V, V <sub>GS</sub> = +20/-5 V, R <sub>g,off</sub> = 1 Ω	T <sub>vj</sub> = 25°C, T <sub>vj</sub> = 175°C	-	220 228	-	ns
T <sub>f</sub>	Fall Time, Inductive Load	I <sub>DS</sub> = 400 A, V <sub>DS</sub> = 800 V, V <sub>GS</sub> = +20/-5 V, R <sub>g,off</sub> = 1 Ω	T <sub>vj</sub> = 25°C T <sub>vj</sub> = 175°C	-	51 61	-	ns
E <sub>ON</sub>	Turn-On Switching Loss (including diode reverse recovery loss)	I <sub>DS</sub> = 400 A, V <sub>DS</sub> = 800 V, V <sub>GS</sub> = +20/-5 V, L <sub>s</sub> = 17 nH, R <sub>g,on</sub> = 3Ω	di/dt = 8.4 A/ns, T <sub>vj</sub> = 25°C di/dt = 9.7 A/ns, T <sub>vj</sub> = 175°C	-	26 28	-	mJ
E <sub>OFF</sub>	Turn-Off Switching Loss	I <sub>DS</sub> = 400A, V <sub>DS</sub> = 800 V, V <sub>GS</sub> = +20/-5 V, L <sub>s</sub> = 17 nH, R <sub>g,off</sub> = 1 Ω	dv/dt = 19.8 V/ns, T <sub>vj</sub> = 25°C dv/dt = 16.8 V/ns, T <sub>vj</sub> = 175°C	-	14 17	-	mJ
E <sub>sc</sub>	Short Circuit Energy Withstand	V <sub>GS</sub> = 20 V, V <sub>DS</sub> = 800 V T <sub>vj</sub> = 25°C T <sub>vj</sub> = 175°C		-	12 11	-	J

# NVVR26A120M1WST

## BODY DIODE CHARACTERISTICS ( $T_{vj} = 25^{\circ}\text{C}$ , Unless Otherwise Specified)

Parameters		Conditions		Min	Typ	Max	Unit
$V_{SD}$	Diode Forward Voltage (Terminal)	$V_{GS} = -5\text{ V}$ , $I_{SD} = 400\text{ A}$ $T_{vj} = 25^{\circ}\text{C}$ $T_{vj} = 175^{\circ}\text{C}$		-	3.8 3.3	-	V
$E_{rr}$	Reverse Recovery Energy	$I_{SD} = 400\text{ A}$ , $V_R = 800\text{ V}$ , $V_{GS} = -5\text{ V}$ , $L_s = 17\text{ nH}$ , $R_{g,on} = 3\ \Omega$	$di/dt = 8.4\text{ A/ns}$ , $T_{vj} = 25^{\circ}\text{C}$ $di/dt = 9.7\text{ A/ns}$ , $T_{vj} = 175^{\circ}\text{C}$	-	0.4 2.1	-	mJ
$Q_{RR}$	Recovered Charge	$I_{SD} = 400\text{ A}$ , $V_R = 800\text{ V}$ , $V_{GS} = -5\text{ V}$ , $R_{g,on} = 3\ \Omega$	$T_{vj} = 25^{\circ}\text{C}$ $T_{vj} = 175^{\circ}\text{C}$	-	2.3 8.6	-	$\mu\text{C}$
$I_{RR}$	Peak Reverse Recovery Current	$I_{SD} = 400\text{ A}$ , $V_R = 800\text{ V}$ , $V_{GS} = -5\text{ V}$ , $R_{g,on} = 3\ \Omega$	$T_{vj} = 25^{\circ}\text{C}$ $T_{vj} = 175^{\circ}\text{C}$	-	527 650	-	A

## NTC SENSOR CHARACTERISTICS ( $T_{vj} = 25^{\circ}\text{C}$ , Unless Otherwise Specified)

Parameters		Conditions	Min	Typ	Max	Unit
R25	Rated Resistance	$T_c = 25^{\circ}\text{C}$	-	10	-	$\text{k}\Omega$
$\Delta R/R$	Deviation of R100	$T_c = 100^{\circ}\text{C}$ , $R_{100} = 877\ \Omega$	-3	-	+3	%
P25	Power Dissipation	$T_c = 25^{\circ}\text{C}$	-	-	125	mW
B25/85	B-Value	$R = R_{25} \exp [B_{25/85} (1/T - 1/298)]$	-1%	3610	+1%	K

## THERMAL CHARACTERISTICS

Symbol	Parameter	Test Conditions	Min	Typ	Max	Unit
$R_{th,J-C}$	FET Junction to Case		-	0.025	0.028	$^{\circ}\text{C/W}$
$R_{th,J-F}$	FET Junction to Fluid	$R_{th}$ , Junction to Fluid, 10 L/min, $65^{\circ}\text{C}$ , 50/50 EGW, Ref. Heatsink	-	0.11	-	$^{\circ}\text{C/W}$

TYPICAL CHARACTERISTICS

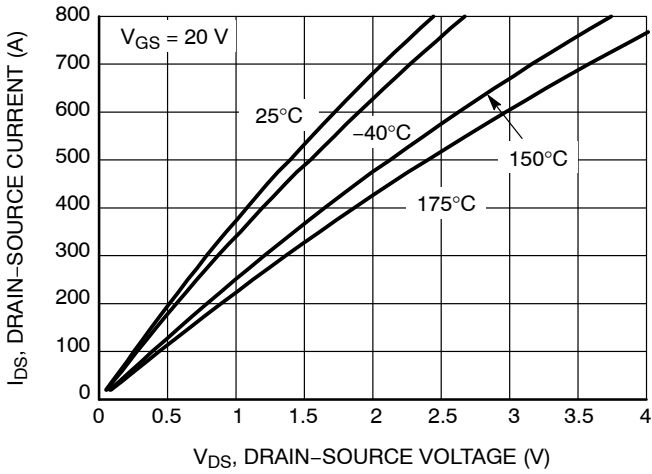

Figure 2. Output Characteristics

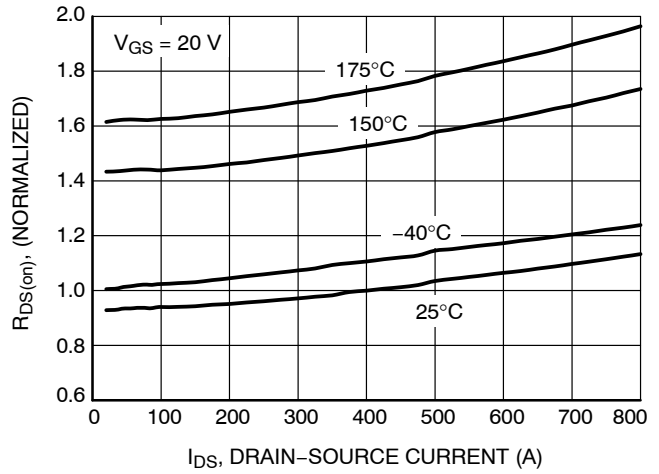

Figure 3. Normalized On-state Resistance vs. Drain Current

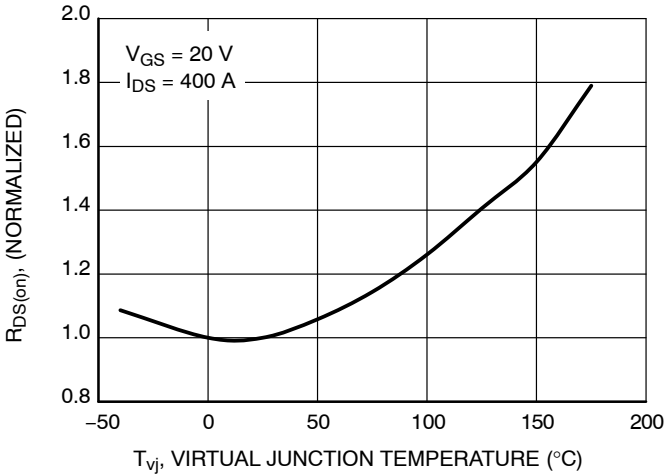

Figure 4. Normalized On-state Resistance vs. Temperature

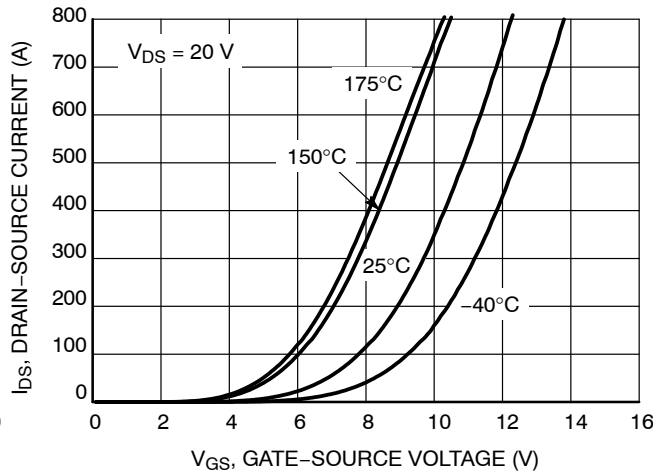

Figure 5. Transfer Characteristic

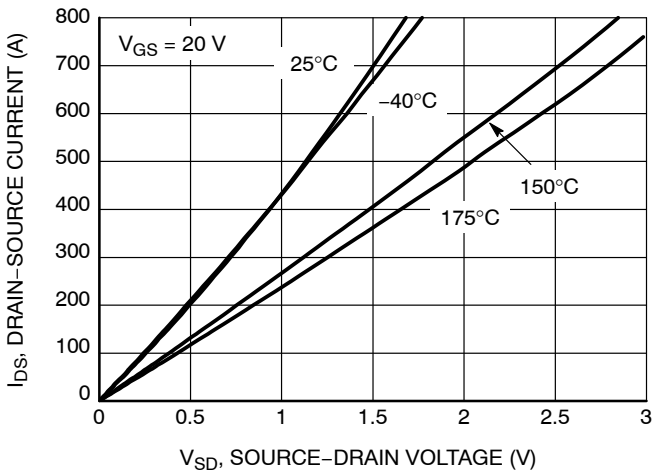

Figure 6. 3rd Quadrant Characteristic at  $V_{GS} = 20\text{ V}$

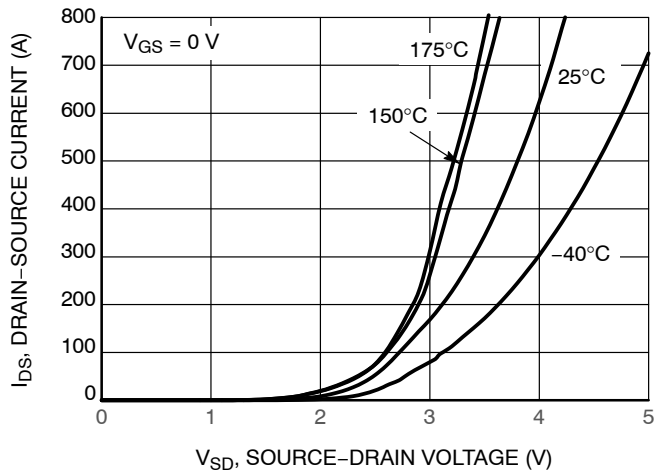

Figure 7. 3rd Quadrant Characteristic at  $V_{GS} = 0\text{ V}$

# NVVR26A120M1WST

## TYPICAL CHARACTERISTICS

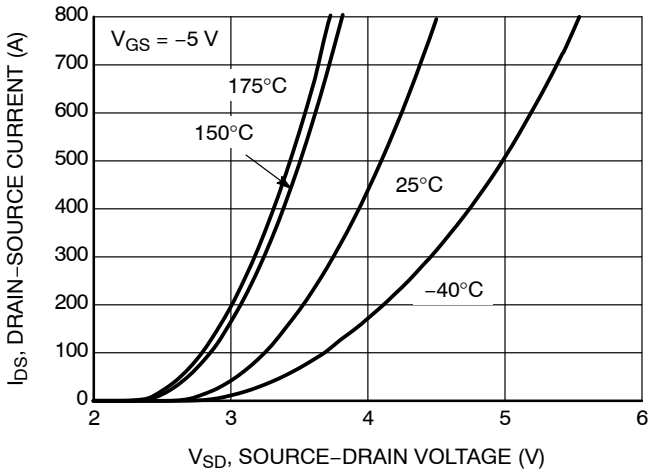

Figure 8. 3rd Quadrant Characteristic at  $V_{GS} = -5\text{ V}$

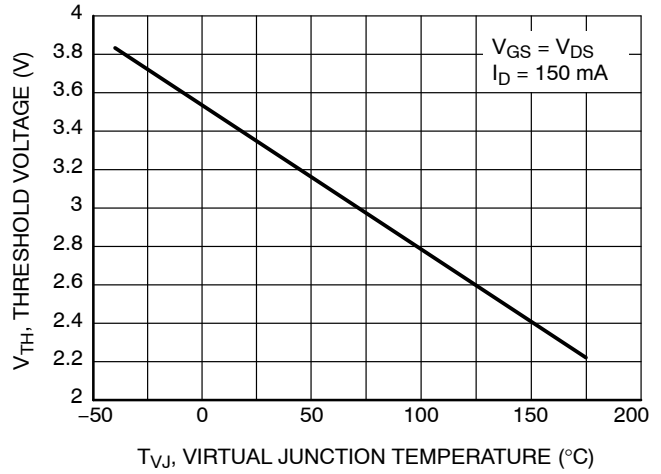

Figure 9. Gate Threshold Voltage vs. Temperature

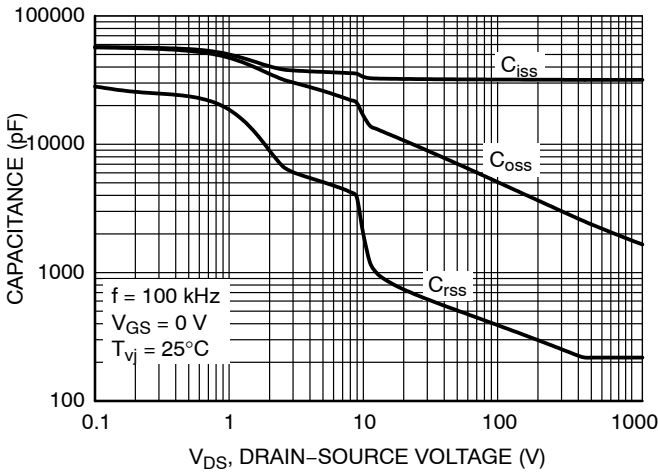

Figure 10. Typical Capacitance vs. Drain-Source Voltage

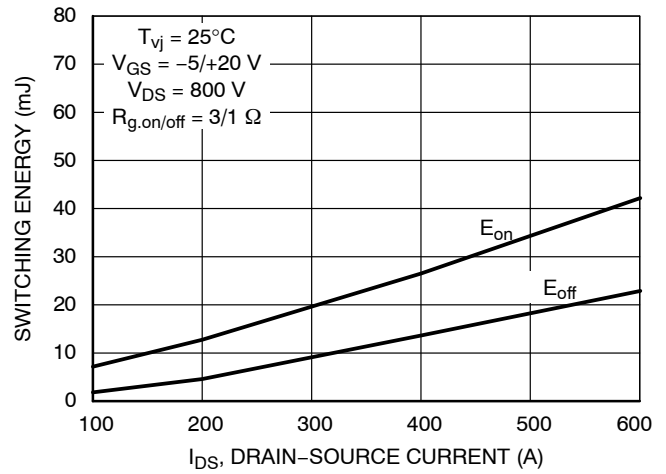

Figure 11. Switching Energies at  $25^\circ\text{C}$

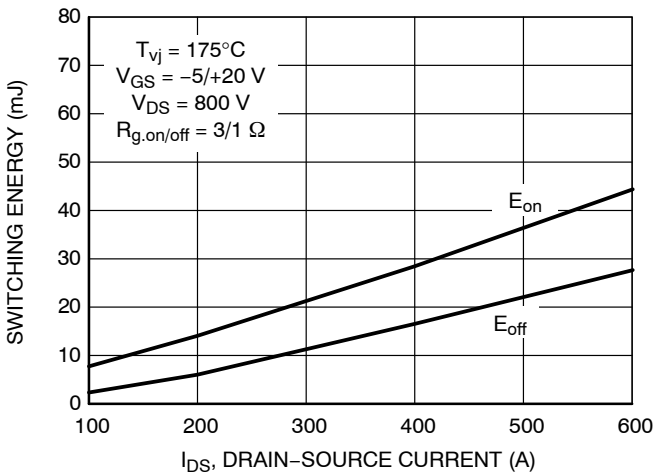

Figure 12. Switching Energies at  $175^\circ\text{C}$

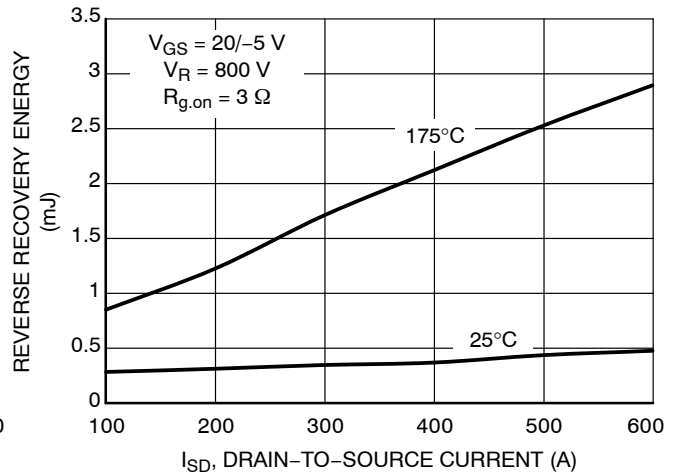
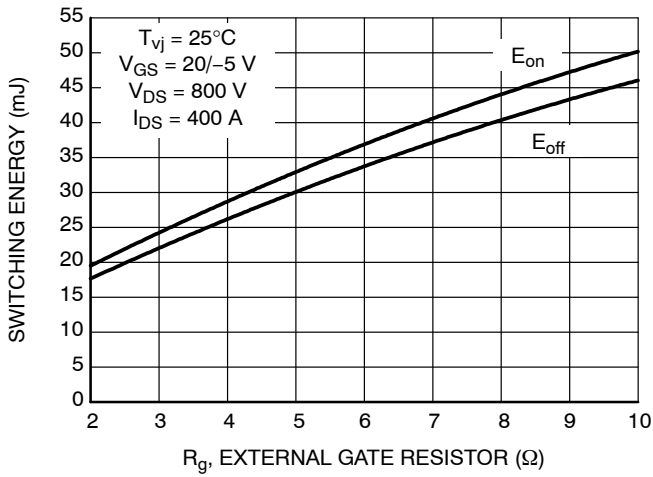

Figure 13. Reverse Recovery Energy vs. Drain-Source Current

# NVVR26A120M1WST

## TYPICAL CHARACTERISTICS



**Figure 14. Switching Energies vs. External Gate Resistor**

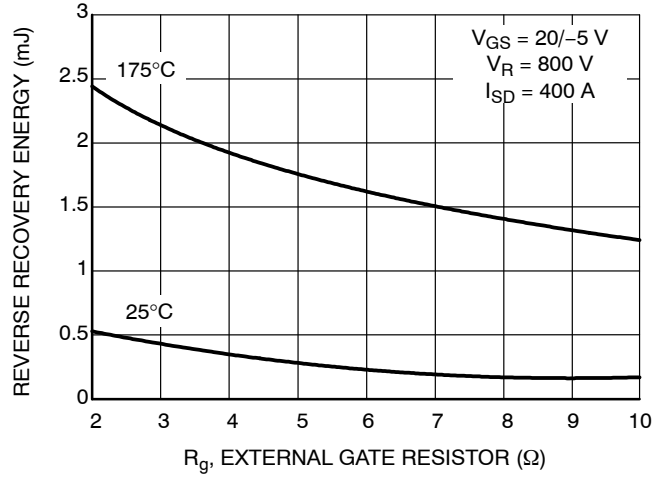

**Figure 15. Reverse Recovery Energy vs. External Gate Resistor**

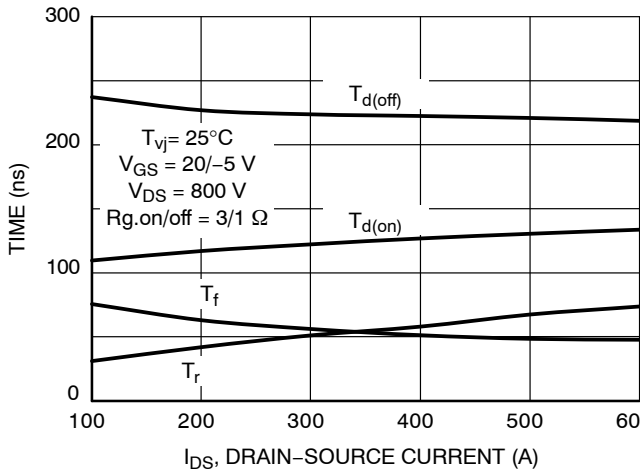

**Figure 16. Timing Characteristics vs. Drain-Source Current**

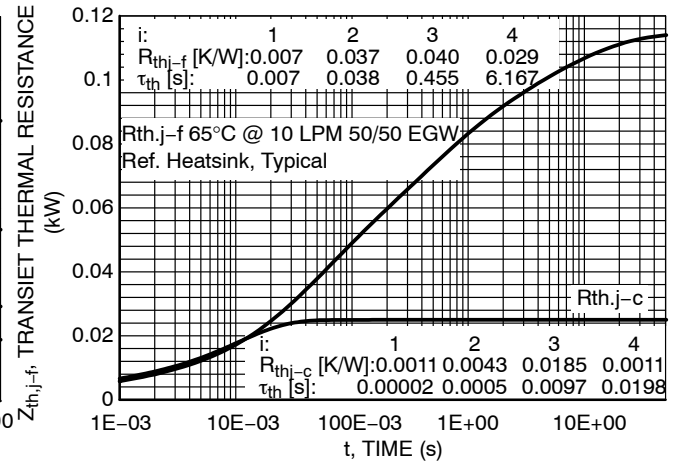

**Figure 17. Typical Thermal Impedance**

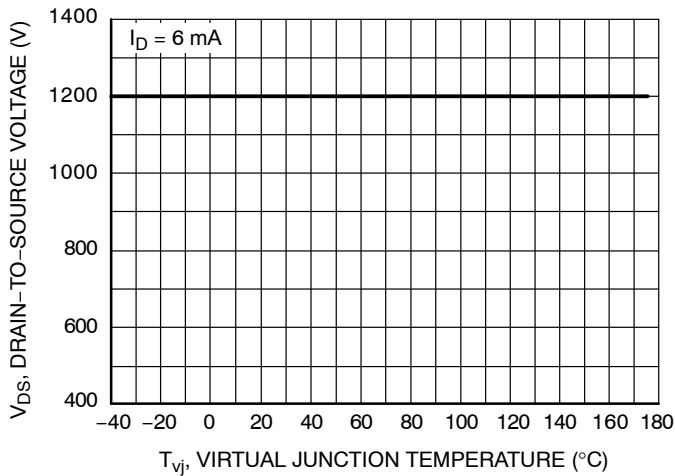

**Figure 18. MOSFET Breakdown Voltage vs.  $T_{vj}$**

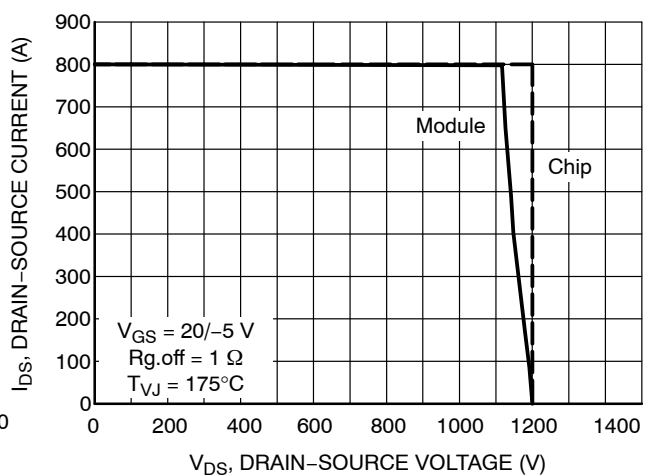

**Figure 19. MOSFET RBSOA of Chip and Module**



# NVVR26A120M1WST

## TYPICAL CHARACTERISTICS

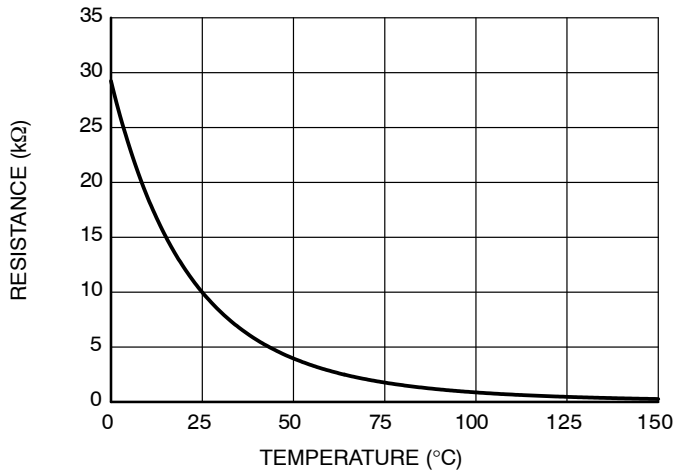

Figure 20. NTC Resistance vs. Temperature

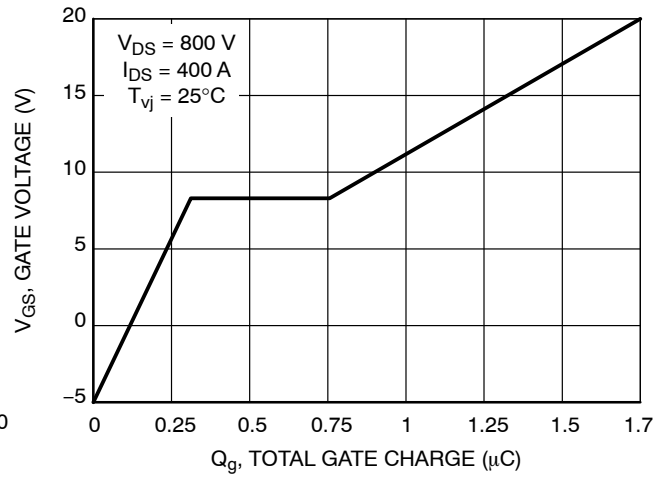
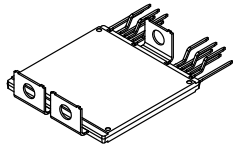

Figure 21. Gate Charge vs. Gate-Source

# MECHANICAL CASE OUTLINE

## PACKAGE DIMENSIONS

ON Semiconductor®



### AHPM15-CDA MODULE

#### CASE MODHG

#### ISSUE B

DATE 22 SEP 2021



END VIEW

$\oplus \varnothing 0.60 \text{ (M) C A B}$

NOTES:

1. DIMENSIONING AND TOLERANCING PER ASME Y14.5M, 2009.
2. CONTROLLING DIMENSION: MILLIMETERS
3. DIMENSIONS D & E DO NOT INCLUDE MOLD PROTRUSIONS
4. DIMENSIONS b,b1,b2 DO NOT INCLUDE DAMBAR REMAIN.
5. MARKING AREA.

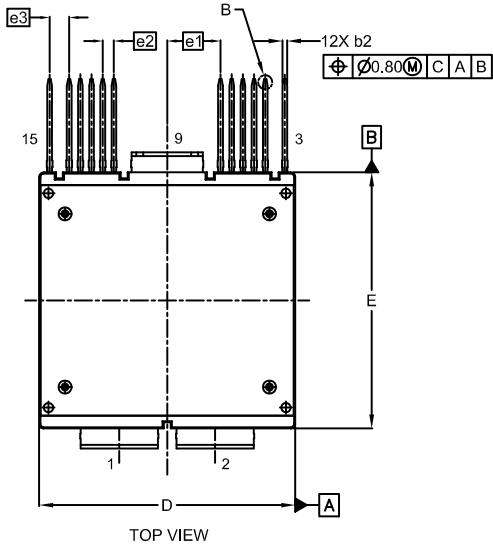

TOP VIEW

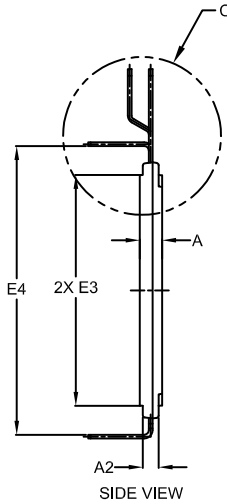

SIDE VIEW

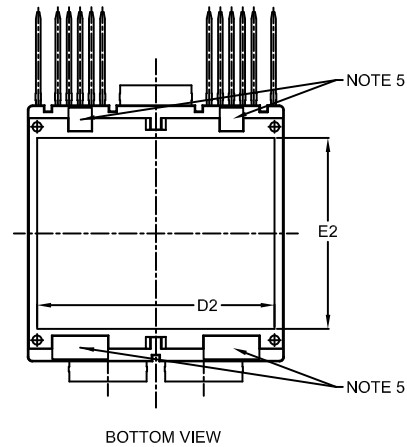

BOTTOM VIEW

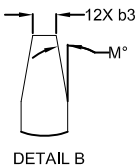

DETAIL B

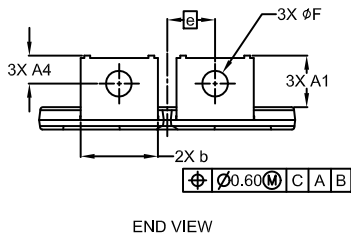

END VIEW

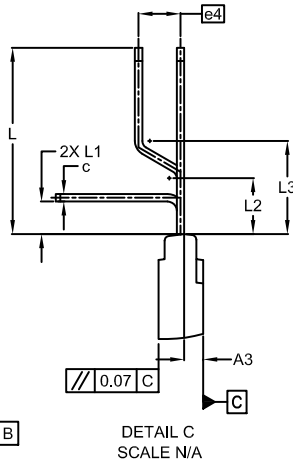

DETAIL C  
SCALE N/A

DIM	MILLIMETERS		
	MIN.	NOM.	MAX.
A	4.60	4.80	5.00
A1	10.75	11.05	11.35
A2	3.20	3.40	3.60
A3	1.70	2.05	2.40
A4	5.70	6.00	6.30
b	16.50	16.60	16.70
b1	15.20	15.30	15.40
b2	0.90	1.00	1.10
b3	0.50 REF		
c	0.70	0.80	0.90
D	54.80	55.00	55.20
D2	50.40	51.00	51.60

DIM	MILLIMETERS		
	MIN.	NOM.	MAX.
E	54.80	55.00	55.20
E2	40.40	41.00	41.60
E3	49.40	49.60	49.80
E4	61.50	62.00	62.50
e	10.00	10.30	10.60
e1	11.15	11.45	11.75
e2	2.40 BSC		
e3	4.20 BSC		
e4	4.20	4.50	4.80
F	5.40	5.50	5.60
L	19.60	20.00	20.40
L1	3.10	3.50	3.90
L2	6.00 REF		
L3	10.00 REF		
M	10° REF		

<b>DOCUMENT NUMBER:</b>	<b>98AON23821H</b>	Electronic versions are uncontrolled except when accessed directly from the Document Repository. Printed versions are uncontrolled except when stamped "CONTROLLED COPY" in red.
<b>DESCRIPTION:</b>	<b>AHPM15-CDA MODULE</b>	<b>PAGE 1 OF 2</b>

ON Semiconductor and are trademarks of Semiconductor Components Industries, LLC dba ON Semiconductor or its subsidiaries in the United States and/or other countries. ON Semiconductor reserves the right to make changes without further notice to any products herein. ON Semiconductor makes no warranty, representation or guarantee regarding the suitability of its products for any particular purpose, nor does ON Semiconductor assume any liability arising out of the application or use of any product or circuit, and specifically disclaims any and all liability, including without limitation special, consequential or incidental damages. ON Semiconductor does not convey any license under its patent rights nor the rights of others.

**AHPM15-CDA MODULE**  
**CASE MODHG**  
**ISSUE A**

DATE 22 SEP 2021

**GENERIC**  
**MARKING DIAGRAM\***

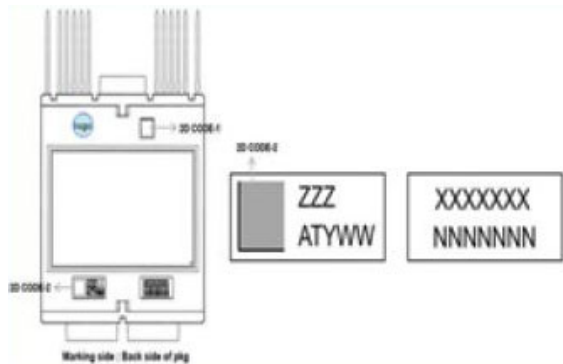

ZZZ = Assembly Lot Code  
 AT = Assembly & Test Location  
 Y = Year  
 WW = Work Week  
 NNNN = Serial Number

\*This information is generic. Please refer to device data sheet for actual part marking. Pb-Free indicator, "G" or microdot "▪", may or may not be present. Some products may not follow the Generic Marking.

<b>DOCUMENT NUMBER:</b>	<b>98AON23821H</b>	Electronic versions are uncontrolled except when accessed directly from the Document Repository. Printed versions are uncontrolled except when stamped "CONTROLLED COPY" in red.
<b>DESCRIPTION:</b>	<b>AHPM15-CDA MODULE</b>	<b>PAGE 2 OF 2</b>

ON Semiconductor and  are trademarks of Semiconductor Components Industries, LLC dba ON Semiconductor or its subsidiaries in the United States and/or other countries. ON Semiconductor reserves the right to make changes without further notice to any products herein. ON Semiconductor makes no warranty, representation or guarantee regarding the suitability of its products for any particular purpose, nor does ON Semiconductor assume any liability arising out of the application or use of any product or circuit, and specifically disclaims any and all liability, including without limitation special, consequential or incidental damages. ON Semiconductor does not convey any license under its patent rights nor the rights of others.

**onsemi**, **Onsemi**, and other names, marks, and brands are registered and/or common law trademarks of Semiconductor Components Industries, LLC dba "**onsemi**" or its affiliates and/or subsidiaries in the United States and/or other countries. **onsemi** owns the rights to a number of patents, trademarks, copyrights, trade secrets, and other intellectual property. A listing of **onsemi**'s product/patent coverage may be accessed at [www.onsemi.com/site/pdf/Patent-Marking.pdf](http://www.onsemi.com/site/pdf/Patent-Marking.pdf). **onsemi** reserves the right to make changes at any time to any products or information herein, without notice. The information herein is provided "as-is" and **onsemi** makes no warranty, representation or guarantee regarding the accuracy of the information, product features, availability, functionality, or suitability of its products for any particular purpose, nor does **onsemi** assume any liability arising out of the application or use of any product or circuit, and specifically disclaims any and all liability, including without limitation special, consequential or incidental damages. Buyer is responsible for its products and applications using **onsemi** products, including compliance with all laws, regulations and safety requirements or standards, regardless of any support or applications information provided by **onsemi**. "Typical" parameters which may be provided in **onsemi** data sheets and/or specifications can and do vary in different applications and actual performance may vary over time. All operating parameters, including "Typicals" must be validated for each customer application by customer's technical experts. **onsemi** does not convey any license under any of its intellectual property rights nor the rights of others. **onsemi** products are not designed, intended, or authorized for use as a critical component in life support systems or any FDA Class 3 medical devices or medical devices with a same or similar classification in a foreign jurisdiction or any devices intended for implantation in the human body. Should Buyer purchase or use **onsemi** products for any such unintended or unauthorized application, Buyer shall indemnify and hold **onsemi** and its officers, employees, subsidiaries, affiliates, and distributors harmless against all claims, costs, damages, and expenses, and reasonable attorney fees arising out of, directly or indirectly, any claim of personal injury or death associated with such unintended or unauthorized use, even if such claim alleges that **onsemi** was negligent regarding the design or manufacture of the part. **onsemi** is an Equal Opportunity/Affirmative Action Employer. This literature is subject to all applicable copyright laws and is not for resale in any manner.

## ADDITIONAL INFORMATION

### TECHNICAL PUBLICATIONS:

Technical Library: [www.onsemi.com/design/resources/technical-documentation](http://www.onsemi.com/design/resources/technical-documentation)  
onsemi Website: [www.onsemi.com](http://www.onsemi.com)

### ONLINE SUPPORT: [www.onsemi.com/support](http://www.onsemi.com/support)

For additional information, please contact your local Sales Representative at [www.onsemi.com/support/sales](http://www.onsemi.com/support/sales)