

NXH25T120L2Q1PG

Q1 3-Phase TNPC Module

The NXH25T120L2Q1PG/PTG is a case power module containing a three channel T-type neutral-point clamped (TNPC) circuit. Each channel has a two 1200 V, 25 A IGBTs with inverse diodes and two 650 V, 20 A IGBTs with inverse diodes. The module contains an NTC thermistor.

Features

- Low Package Height
- Compact 82.5 mm x 37.4 mm x 12 mm Package
- Press-fit Pins
- Options with Pre-applied Thermal Interface Material (TIM) and Without Pre-applied TIM
- Thermistor

Typical Applications

- Solar Inverters
- UPS

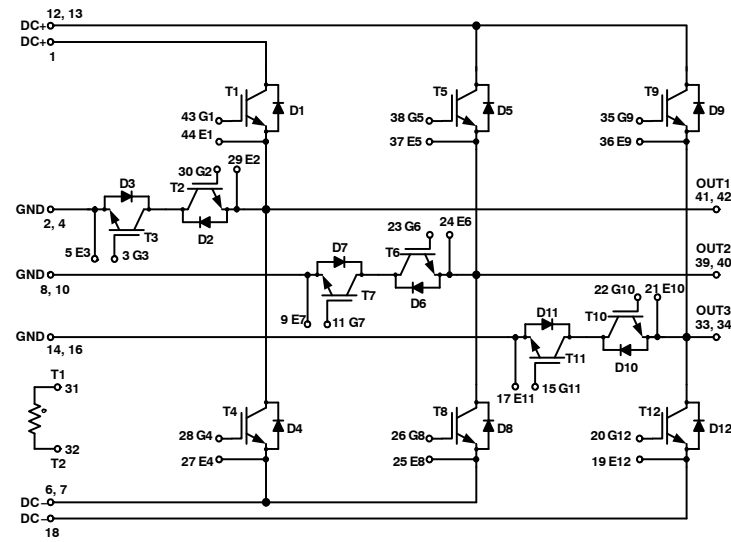
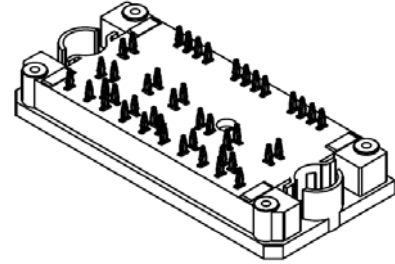

Figure 1. NXH25T120L2Q1PG/PTG Schematic Diagram



ON Semiconductor®

www.onsemi.com



Q1 3-TNPC
PRESS FIT
CASE 180AS

DEVICE MARKING

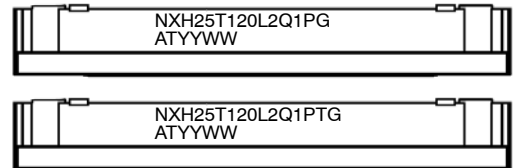

NXH25T120L2Q1P or
NXH25T120L2Q1PT
= Specific Device Code
G = Pb-Free Package
AT = Assembly & Test Site Code
YYWW = Year and Work Week Code

PIN ASSIGNMENTS

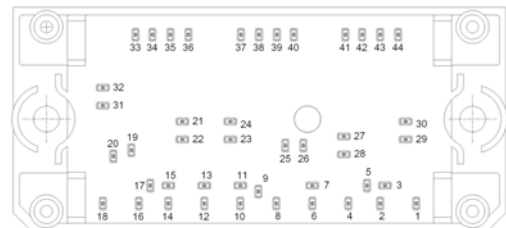

ORDERING INFORMATION

See detailed ordering and shipping information on page 5 of this data sheet.

NXH25T120L2Q1PG

Table 1. MAXIMUM RATINGS (Note 1)

Rating	Symbol	Value	Unit
HALF BRIDGE IGBT			
Collector–Emitter Voltage	V_{CES}	1200	V
Gate–Emitter Voltage	V_{GE}	± 20	V
Continuous Collector Current @ $T_c = 80^\circ\text{C}$ ($T_J = 175^\circ\text{C}$)	I_C	25	A
Pulsed Collector Current ($T_J = 175^\circ\text{C}$)	I_{Cpulse}	75	A
Maximum Power Dissipation ($T_J = 175^\circ\text{C}$)	P_{tot}	81	W
Short Circuit Withstand Time @ $V_{GE} = 15\text{ V}$, $V_{CE} = 600\text{ V}$, $T_J \leq 150^\circ\text{C}$	T_{sc}	5	μs
Minimum Operating Junction Temperature	T_{JMIN}	-40	$^\circ\text{C}$
Maximum Operating Junction Temperature	T_{JMAX}	150	$^\circ\text{C}$

NEUTRAL POINT IGBT			
Collector–Emitter Voltage	V_{CES}	650	V
Gate–Emitter Voltage	V_{GE}	± 20	V
Continuous Collector Current @ $T_c = 80^\circ\text{C}$ ($T_J = 175^\circ\text{C}$)	I_C	20	A
Pulsed Collector Current ($T_J = 175^\circ\text{C}$)	I_{Cpulse}	60	A
Maximum Power Dissipation ($T_J = 175^\circ\text{C}$)	P_{tot}	50	W
Short Circuit Withstand Time @ $V_{GE} = 15\text{ V}$, $V_{CE} = 400\text{ V}$, $T_J \leq 150^\circ\text{C}$	T_{sc}	5	μs
Minimum Operating Junction Temperature	T_{JMIN}	-40	$^\circ\text{C}$
Maximum Operating Junction Temperature	T_{JMAX}	150	$^\circ\text{C}$

HALF BRIDGE DIODE			
Peak Repetitive Reverse Voltage	V_{RRM}	1200	V
Continuous Forward Current @ $T_c = 80^\circ\text{C}$ ($T_J = 175^\circ\text{C}$)	I_F	15	A
Repetitive Peak Forward Current ($T_J = 175^\circ\text{C}$)	I_{FRM}	45	A
Maximum Power Dissipation ($T_J = 175^\circ\text{C}$)	P_{tot}	43	W
Minimum Operating Junction Temperature	T_{JMIN}	-40	$^\circ\text{C}$
Maximum Operating Junction Temperature	T_{JMAX}	150	$^\circ\text{C}$

NEUTRAL POINT DIODE			
Peak Repetitive Reverse Voltage	V_{RRM}	650	V
Continuous Forward Current @ $T_c = 80^\circ\text{C}$ ($T_J = 175^\circ\text{C}$)	I_F	15	A
Repetitive Peak Forward Current ($T_J = 175^\circ\text{C}$)	I_{FRM}	45	A
Maximum Power Dissipation ($T_J = 175^\circ\text{C}$)	P_{tot}	39	W
Minimum Operating Junction Temperature	T_{JMIN}	-40	$^\circ\text{C}$
Maximum Operating Junction Temperature	T_{JMAX}	150	$^\circ\text{C}$

THERMAL PROPERTIES			
Storage Temperature range	T_{stg}	-40 to 125	$^\circ\text{C}$

INSULATION PROPERTIES			
Isolation test voltage, $t = 1\text{ sec}$, 60Hz	V_{is}	3000	V_{RMS}
Creepage distance		12.7	mm

Stresses exceeding those listed in the Maximum Ratings table may damage the device. If any of these limits are exceeded, device functionality should not be assumed, damage may occur and reliability may be affected.

1. Refer to ELECTRICAL CHARACTERISTICS, RECOMMENDED OPERATING RANGES and/or APPLICATION INFORMATION for Safe Operating parameters.

Table 2. RECOMMENDED OPERATING RANGES

Rating	Symbol	Min	Max	Unit
Module Operating Junction Temperature	T_J	-40	150	$^\circ\text{C}$

Functional operation above the stresses listed in the Recommended Operating Ranges is not implied. Extended exposure to stresses beyond the Recommended Operating Ranges limits may affect device reliability.

NXH25T120L2Q1PG

Table 3. ELECTRICAL CHARACTERISTICS $T_J = 25^\circ\text{C}$ unless otherwise noted

Parameter	Test Conditions	Symbol	Min	Typ	Max	Unit
HALF BRIDGE IGBT CHARACTERISTICS						
Collector–Emitter Cutoff Current	$V_{GE} = 0\text{ V}, V_{CE} = 1200\text{ V}$	I_{CES}	–	–	300	μA
Collector–Emitter Saturation Voltage	$V_{GE} = 15\text{ V}, I_C = 25\text{ A}, T_J = 25^\circ\text{C}$	$V_{CE(sat)}$	–	1.90	2.50	V
	$V_{GE} = 15\text{ V}, I_C = 25\text{ A}, T_J = 125^\circ\text{C}$		–	1.96	–	
Gate–Emitter Threshold Voltage	$V_{GE} = V_{CE}, I_C = 1.5\text{ mA}$	$V_{GE(TH)}$	4.90	5.49	6.50	V
Gate Leakage Current	$V_{GE} = 20\text{ V}, V_{CE} = 0\text{ V}$	I_{GES}	–	–	300	nA
Turn-on Delay Time	$T_J = 25^\circ\text{C}$ $V_{CE} = 350\text{ V}, I_C = 15\text{ A}$ $V_{GE} = \pm 15\text{ V}, R_G = 15\ \Omega$	$t_{d(on)}$	–	59	–	ns
Rise Time		t_r	–	26	–	
Turn-off Delay Time		$t_{d(off)}$	–	242	–	
Fall Time		t_f	–	52	–	
Turn-on Switching Loss per Pulse		E_{on}	–	220	–	
Turn off Switching Loss per Pulse	E_{off}	–	240	–		
Turn-on Delay Time	$T_J = 125^\circ\text{C}$ $V_{CE} = 350\text{ V}, I_C = 15\text{ A}$ $V_{GE} = \pm 15\text{ V}, R_G = 15\ \Omega$	$t_{d(on)}$	–	48	–	ns
Rise Time		t_r	–	29	–	
Turn-off Delay Time		$t_{d(off)}$	–	293	–	
Fall Time		t_f	–	258	–	
Turn-on Switching Loss per Pulse		E_{on}	–	400	–	
Turn off Switching Loss per Pulse	E_{off}	–	710	–		
Input Capacitance	$V_{CE} = 20\text{ V}, V_{GE} = 0\text{ V}, f = 10\text{ kHz}$	C_{ies}	–	8502	–	pF
Output Capacitance		C_{oes}	–	187	–	
Reverse Transfer Capacitance		C_{res}	–	154	–	
Total Gate Charge	$V_{CE} = 600\text{ V}, I_C = 25\text{ A}, V_{GE} = \pm 15\text{ V}$	Q_g	–	352	–	nC
Thermal Resistance – chip-to–heatsink	Thermal grease, Thickness $\leq 2.25\text{ Mil}$, $\lambda = 2.9\text{ W/mK}$	R_{thJH}	–	1.17	–	$^\circ\text{C/W}$

NEUTRAL POINT DIODE CHARACTERISTICS

Diode Forward Voltage	$I_F = 15\text{ A}, T_J = 25^\circ\text{C}$	V_F	–	2.43	–	V
	$I_F = 15\text{ A}, T_J = 125^\circ\text{C}$		–	1.60	–	
Combined IGBT + Diode Voltage Drop	$I_F = 15\text{ A}, T_J = 25^\circ\text{C}$	V_{DT}	–	3.76	4.60	V
Reverse Recovery Time	$T_J = 25^\circ\text{C}$ $V_{CE} = 350\text{ V}, I_C = 15\text{ A}$ $V_{GE} = \pm 15\text{ V}, R_G = 15\ \Omega$	t_{rr}	–	59	–	ns
Reverse Recovery Charge		Q_{rr}	–	0.21	–	μC
Peak Reverse Recovery Current		I_{RRM}	–	7	–	A
Peak Rate of Fall of Recovery Current		di/dt	–	106	–	$\text{A}/\mu\text{s}$
Reverse Recovery Energy		E_{rr}	–	40	–	μJ
Reverse Recovery Time	$T_J = 125^\circ\text{C}$ $V_{CE} = 350\text{ V}, I_C = 15\text{ A}$ $V_{GE} = \pm 15\text{ V}, R_G = 15\ \Omega$	t_{rr}	–	67	–	ns
Reverse Recovery Charge		Q_{rr}	–	0.69	–	μC
Peak Reverse Recovery Current		I_{RRM}	–	19	–	A
Peak Rate of Fall of Recovery Current		di/dt	–	451	–	$\text{A}/\mu\text{s}$
Reverse Recovery Energy		E_{rr}	–	100	–	μJ
Thermal Resistance – chip-to–heatsink	Thermal grease, Thickness $\leq 2.25\text{ Mil}$, $\lambda = 2.9\text{ W/mK}$	R_{thJH}	–	2.45	–	$^\circ\text{C/W}$

NXH25T120L2Q1PG

Table 3. ELECTRICAL CHARACTERISTICS $T_J = 25^\circ\text{C}$ unless otherwise noted

Parameter	Test Conditions	Symbol	Min	Typ	Max	Unit
NEUTRAL POINT IGBT CHARACTERISTICS						
Collector–Emitter Cutoff Current	$V_{GE} = 0\text{ V}, V_{CE} = 650\text{ V}$	I_{CES}	–	–	200	μA
Collector–Emitter Saturation Voltage	$V_{GE} = 15\text{ V}, I_C = 20\text{ A}, T_J = 25^\circ\text{C}$	$V_{CE(sat)}$	–	1.49	–	V
	$V_{GE} = 15\text{ V}, I_C = 20\text{ A}, T_J = 125^\circ\text{C}$		–	1.61	–	
Gate–Emitter Threshold Voltage	$V_{GE} = V_{CE}, I_C = 1.65\text{ mA}$	$V_{GE(TH)}$	4.70	5.68	6.50	V
Gate Leakage Current	$V_{GE} = 20\text{ V}, V_{CE} = 0\text{ V}$	I_{GES}	–	–	200	nA
Turn-on Delay Time	$T_J = 25^\circ\text{C}$ $V_{CE} = 350\text{ V}, I_C = 15\text{ A}$ $V_{GE} = \pm 15\text{ V}, R_G = 15\ \Omega$	$t_{d(on)}$	–	33	–	ns
Rise Time		t_r	–	18	–	
Turn-off Delay Time		$t_{d(off)}$	–	126	–	
Fall Time		t_f	–	43	–	
Turn-on Switching Loss per Pulse		E_{on}	–	250	–	
Turn off Switching Loss per Pulse	E_{off}	–	180	–		
Turn-on Delay Time	$T_J = 125^\circ\text{C}$ $V_{CE} = 350\text{ V}, I_C = 15\text{ A}$ $V_{GE} = \pm 15\text{ V}, R_G = 15\ \Omega$	$t_{d(on)}$	–	31	–	ns
Rise Time		t_r	–	19	–	
Turn-off Delay Time		$t_{d(off)}$	–	138	–	
Fall Time		t_f	–	72	–	
Turn-on Switching Loss per Pulse		E_{on}	–	390	–	
Turn off Switching Loss per Pulse	E_{off}	–	300	–		
Input Capacitance	$V_{CE} = 20\text{ V}, V_{GE} = 0\text{ V}, f = 10\text{ kHz}$	C_{ies}	–	3837	–	pF
Output Capacitance		C_{oes}	–	127	–	
Reverse Transfer Capacitance		C_{res}	–	104	–	
Total Gate Charge	$V_{CE} = 480\text{ V}, I_C = 20\text{ A}, V_{GE} = \pm 15\text{ V}$	Q_g	–	166	–	nC
Thermal Resistance – chip-to–heatsink	Thermal grease, Thickness $\leq 2.25\text{ Mil}$, $\lambda = 2.9\text{ W/mK}$	R_{thJH}	–	1.90	–	$^\circ\text{C/W}$

HALF BRIDGE DIODE CHARACTERISTICS

Diode Forward Voltage	$I_F = 15\text{ A}, T_J = 25^\circ\text{C}$	V_F	–	2.47	3	V
	$I_F = 15\text{ A}, T_J = 125^\circ\text{C}$		–	1.97	–	
Reverse Recovery Time	$T_J = 25^\circ\text{C}$ $V_{CE} = 350\text{ V}, I_C = 15\text{ A}$ $V_{GE} = \pm 15\text{ V}, R_G = 15\ \Omega$	t_{rr}	–	63	–	ns
Reverse Recovery Charge		Q_{rr}	–	0.45	–	μC
Peak Reverse Recovery Current		I_{RRM}	–	17	–	A
Peak Rate of Fall of Recovery Current		di/dt	–	313	–	$\text{A}/\mu\text{s}$
Reverse Recovery Energy		E_{rr}	–	70	–	μJ
Reverse Recovery Time	$T_J = 125^\circ\text{C}$ $V_{CE} = 350\text{ V}, I_C = 15\text{ A}$ $V_{GE} = \pm 15\text{ V}, R_G = 15\ \Omega$	t_{rr}	–	233	–	ns
Reverse Recovery Charge		Q_{rr}	–	1.55	–	μC
Peak Reverse Recovery Current		I_{RRM}	–	22	–	A
Peak Rate of Fall of Recovery Current		di/dt	–	76	–	$\text{A}/\mu\text{s}$
Reverse Recovery Energy		E_{rr}	–	360	–	μJ
Thermal Resistance – chip-to–heatsink	Thermal grease, Thickness $\leq 2.25\text{ Mil}$, $\lambda = 2.9\text{ W/mK}$	R_{thJH}	–	2.21	–	$^\circ\text{C/W}$

NXH25T120L2Q1PG

Table 3. ELECTRICAL CHARACTERISTICS $T_J = 25^\circ\text{C}$ unless otherwise noted

Parameter	Test Conditions	Symbol	Min	Typ	Max	Unit
THERMISTOR CHARACTERISTICS						
Nominal resistance	$T = 25^\circ\text{C}$	R_{25}	-	22	-	$k\Omega$
Nominal resistance	$T = 100^\circ\text{C}$	R_{100}	-	1468	-	Ω
Deviation of R_{25}		$\Delta R/R$	-5		5	%
Power dissipation		P_D	-	200	-	mW
Power dissipation constant			-	2	-	mW/K
B-value	$B(25/50)$, tolerance $\pm 3\%$		-	3950	-	K
B-value	$B(25/100)$, tolerance $\pm 3\%$		-	3998	-	K

ORDERING INFORMATION

Orderable Part Number	Marking	Package	Shipping
NXH25T120L2Q1PG	NXH25T120L2Q1PG	Q1 3-Phase TNPC – Case 180AS Press-fit Pins (Pb – Free)	21 Units / Blister Tray
NXH25T120L2Q1PTG	NXH25T120L2Q1PTG	Q1 3-Phase TNPC – Case 180AS Press-fit Pins with pre-applied thermal interface material (TIM) (Pb – Free)	21 Units / Blister Tray

NXH25T120L2Q1PG

TYPICAL CHARACTERISTICS – HALF BRIDGE IGBT AND DIODE

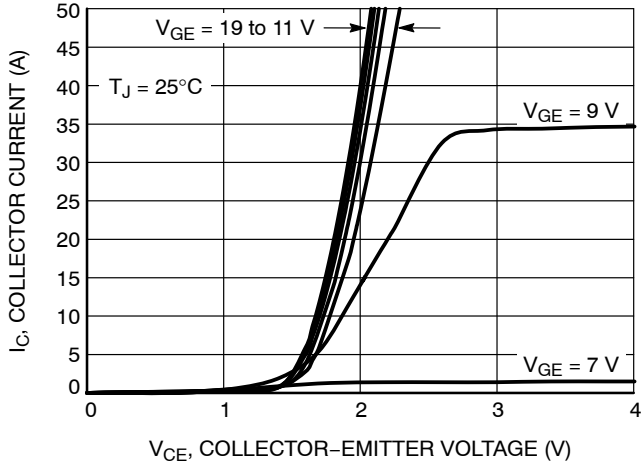

Figure 2. Typical Output Characteristics

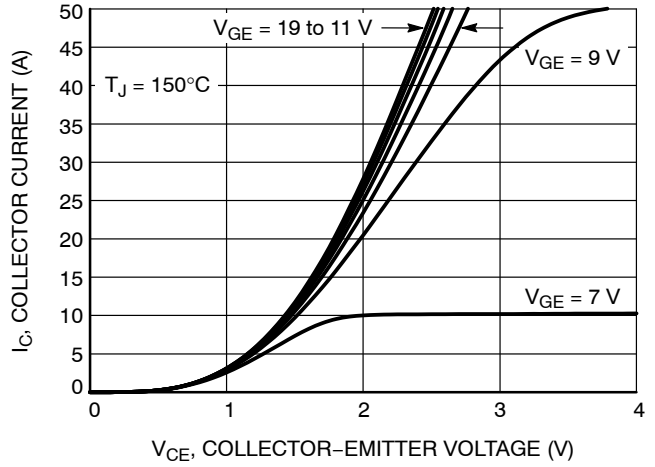

Figure 3. Typical Output Characteristics

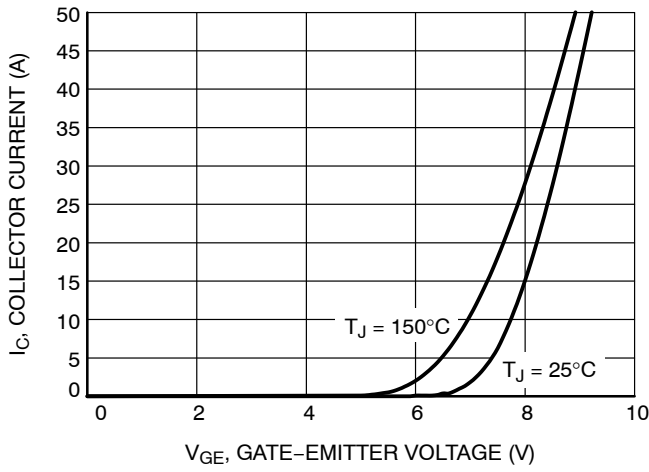

Figure 4. Typical Transfer Characteristics

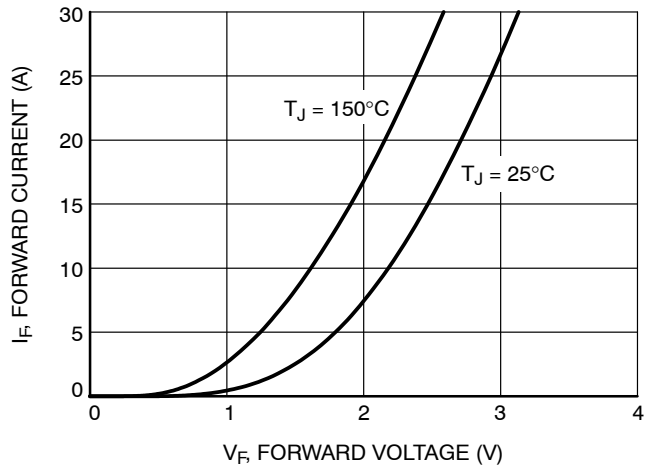

Figure 5. Diode Forward Characteristics

NXH25T120L2Q1PG

TYPICAL CHARACTERISTICS – HALF BRIDGE IGBT AND DIODE

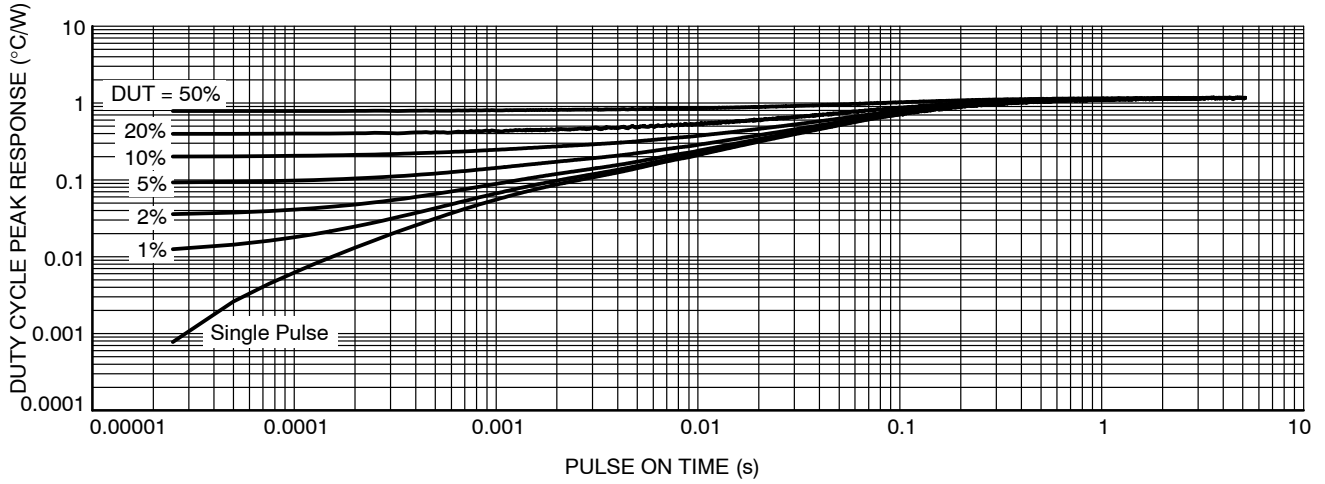

Figure 6. Transient Thermal Impedance (Half Bridge IGBT)

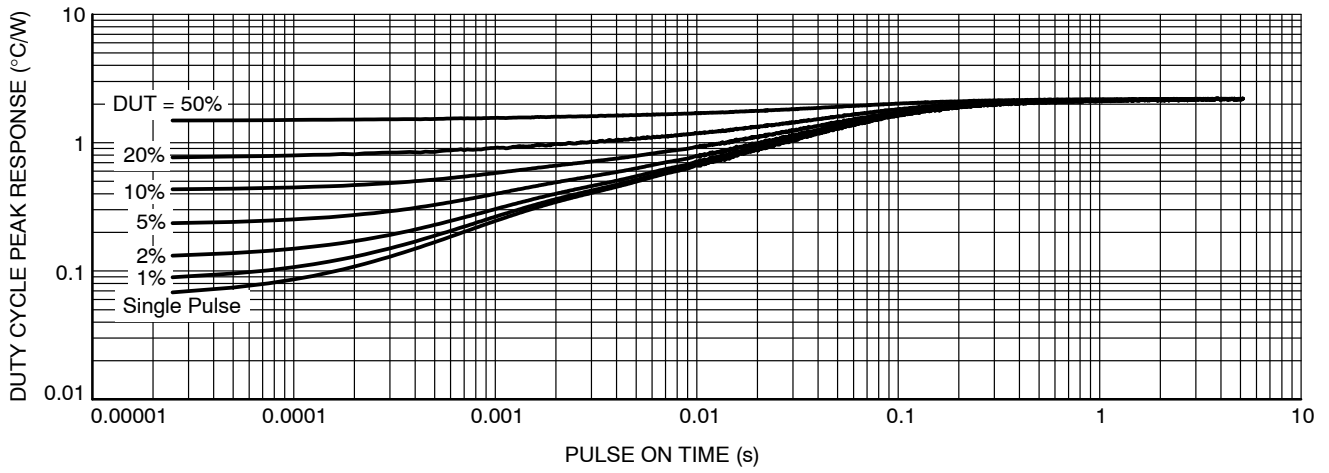

Figure 7. Transient Thermal Impedance (Half Bridge Diode)

NXH25T120L2Q1PG

TYPICAL CHARACTERISTICS – HALF BRIDGE IGBT AND DIODE

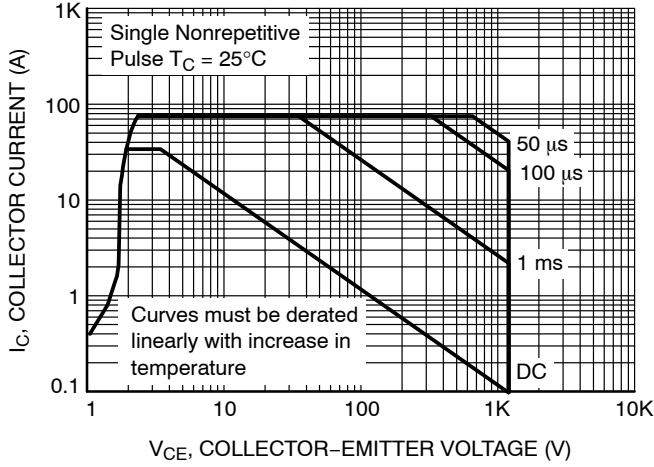

Figure 8. FBSOA

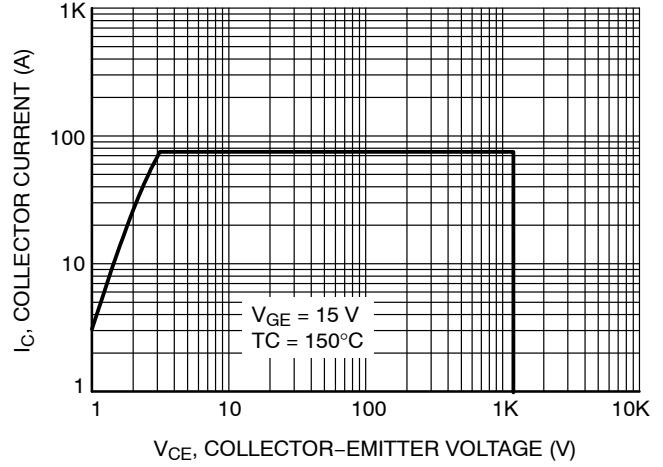

Figure 9. RBSOA

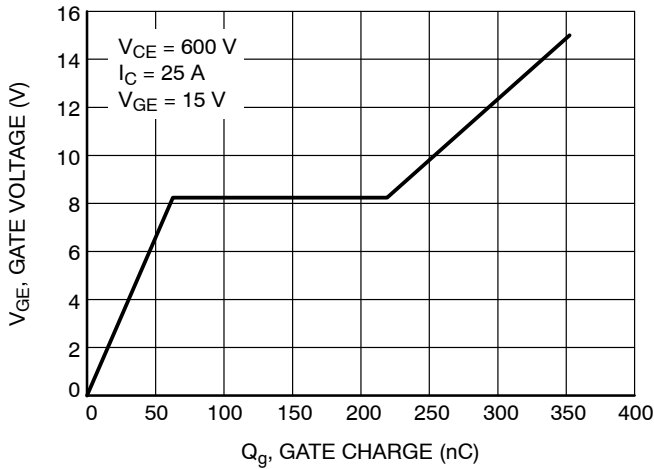

Figure 10. Gate Voltage vs. Gate Charge

TYPICAL CHARACTERISTICS – NEUTRAL POINT IGBT AND DIODE

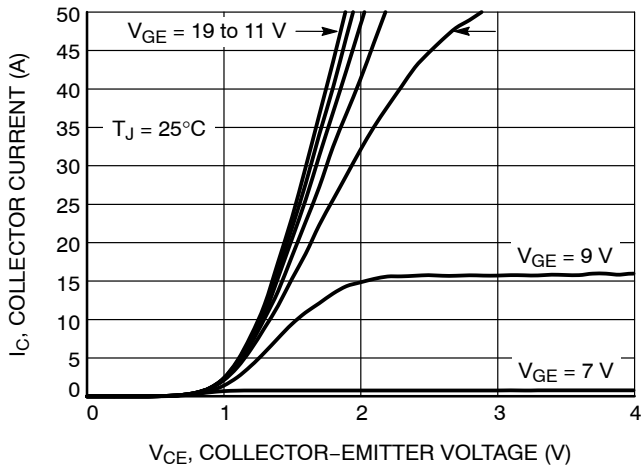

Figure 11. Typical Output Characteristics

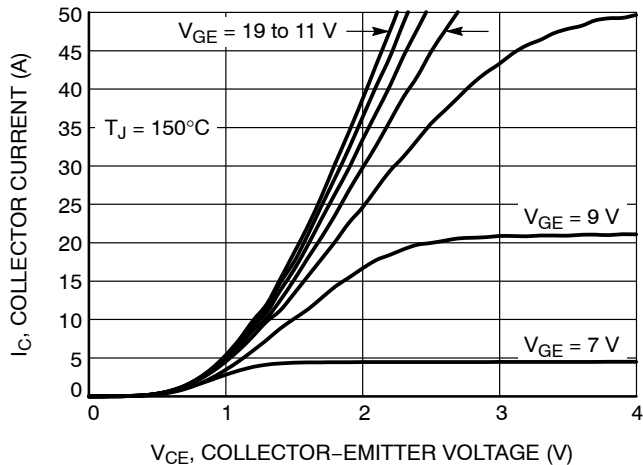

Figure 12. Typical Output Characteristics

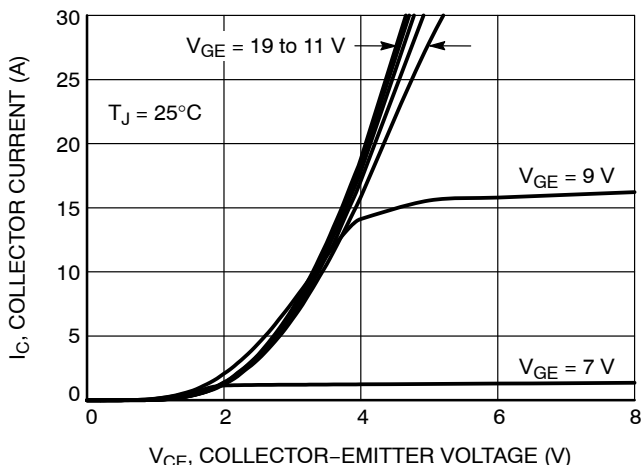

Figure 13. Typical Output Characteristics (Ic vs. VDT)

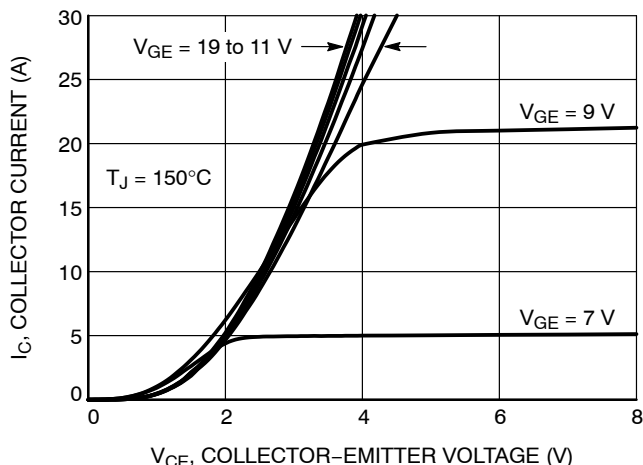

Figure 14. Typical Output Characteristics (Ic vs. VDT)

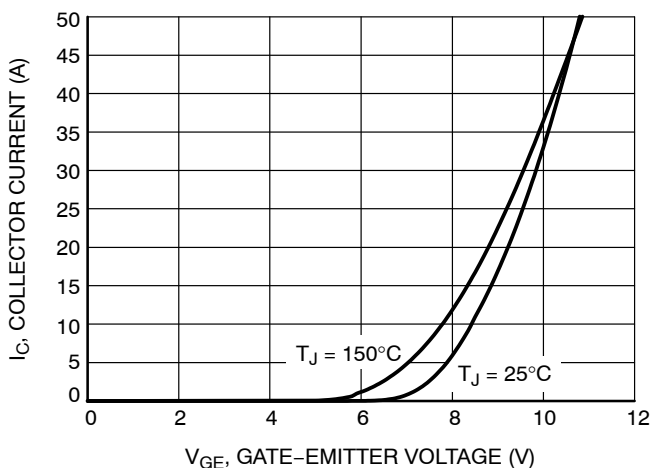

Figure 15. Typical Transfer Characteristics

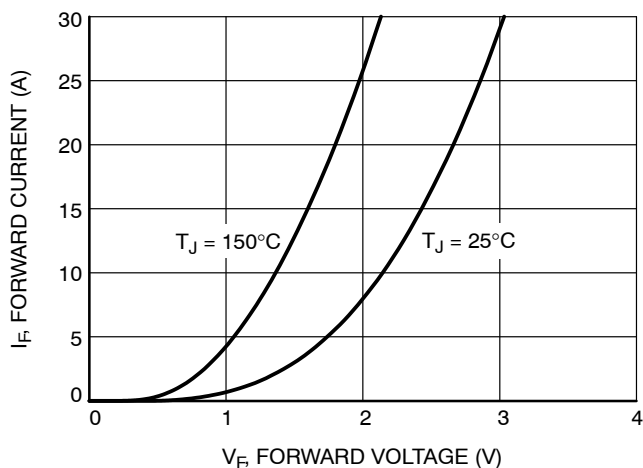

Figure 16. Diode Forward Characteristics

NXH25T120L2Q1PG

TYPICAL CHARACTERISTICS – NEUTRAL POINT IGBT AND DIODE

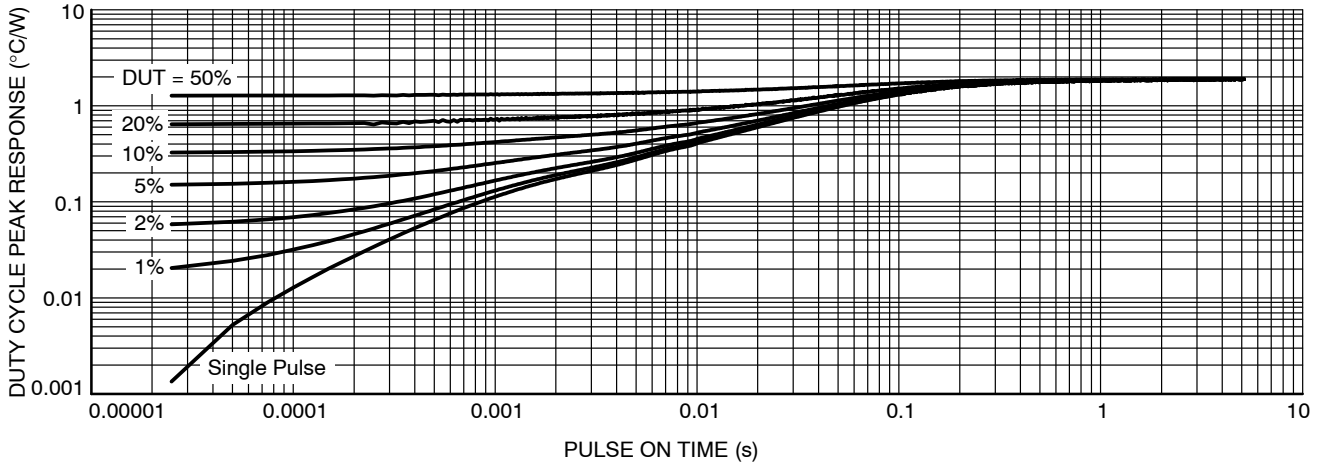

Figure 17. Transient Thermal Impedance (Neutral Point IGBT)

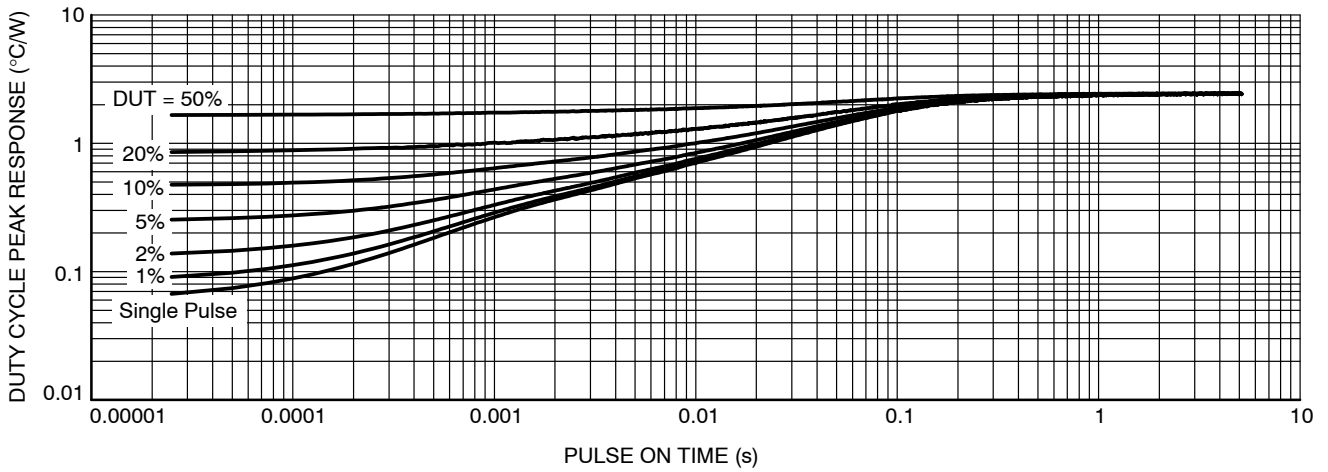

Figure 18. Transient Thermal Impedance (Neutral Point Diode)

TYPICAL CHARACTERISTICS – NEUTRAL POINT IGBT AND DIODE

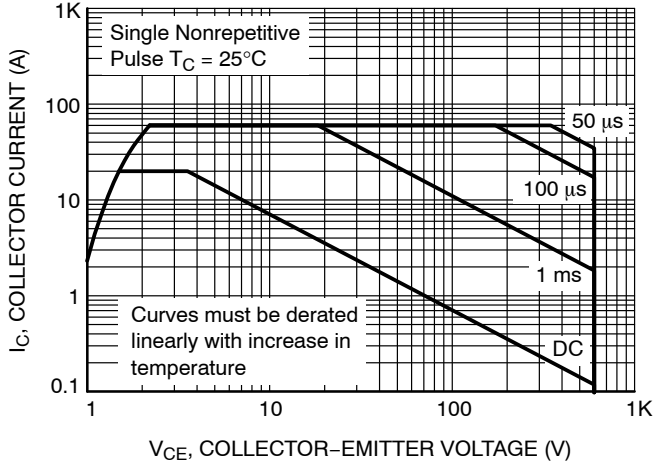

Figure 19. FBSOA

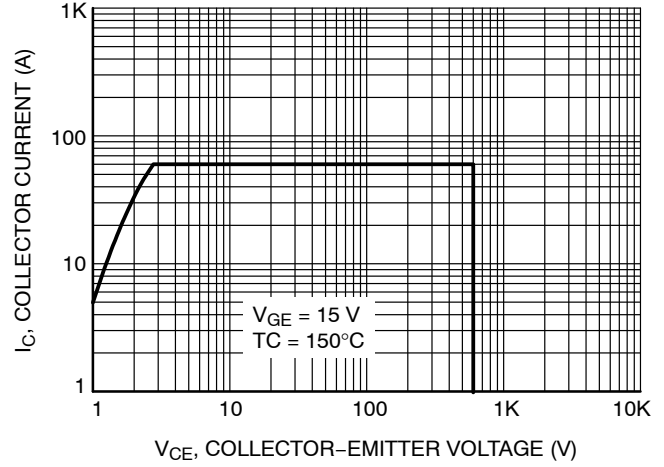

Figure 20. RBSOA

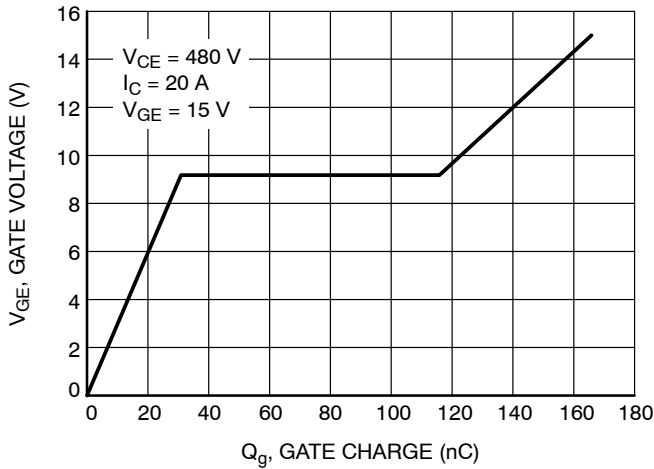

Figure 21. Gate Voltage vs. Gate Charge

NXH25T120L2Q1PG

TYPICAL CHARACTERISTICS – HALF BRIDGE IGBT COMUTATES NEUTRAL POINT DIODE

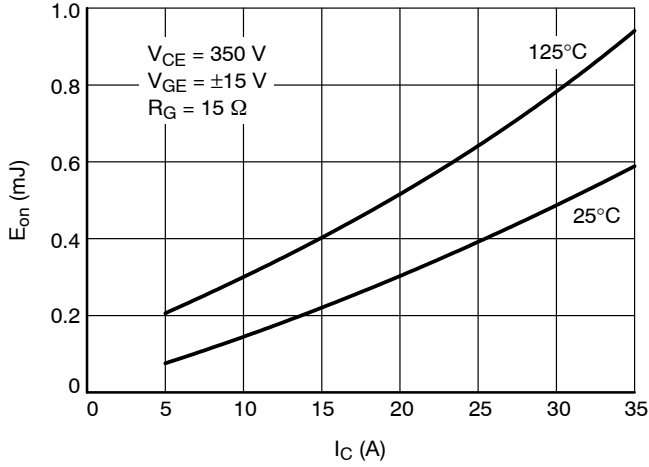

Figure 22. Typical Switching Loss E_{on} vs. I_C

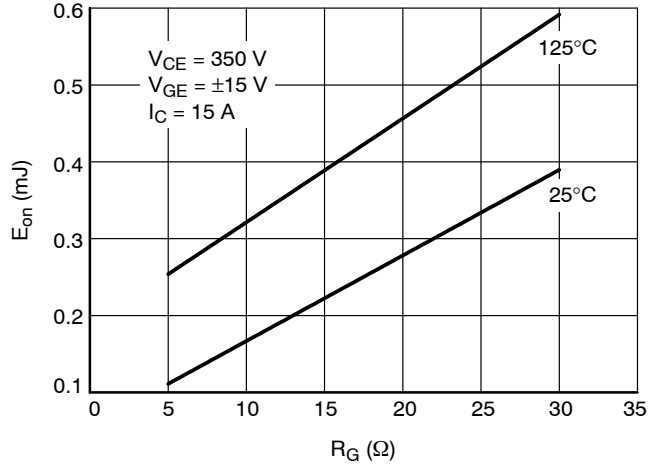

Figure 23. Typical Switching Loss E_{on} vs. R_G

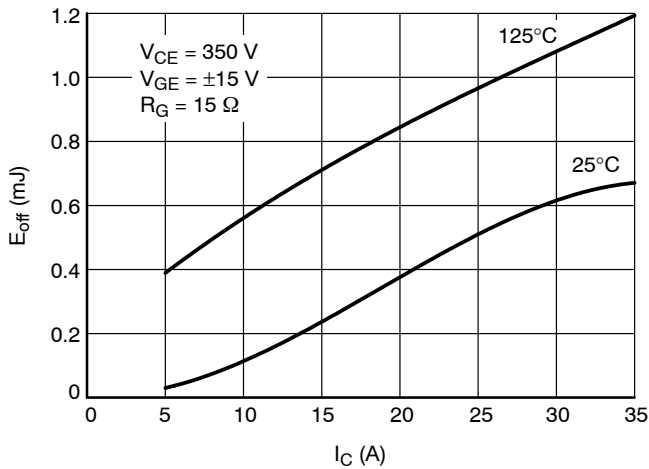

Figure 24. Typical Switching Loss E_{off} vs. I_C

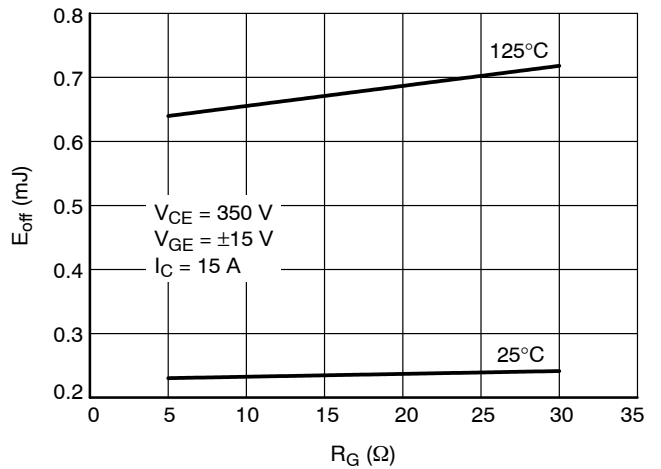

Figure 25. Typical Switching Loss E_{off} vs. R_G

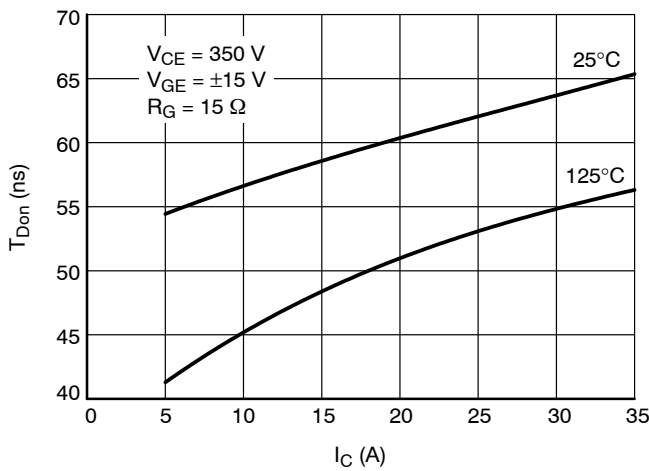

Figure 26. Typical Switching Time T_{Don} vs. I_C

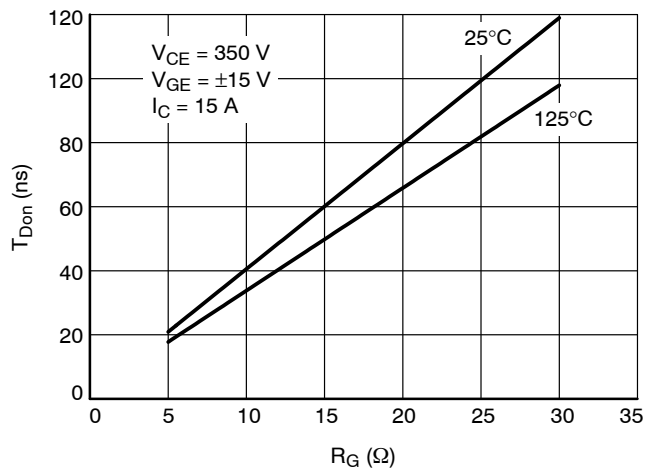

Figure 27. Typical Switching Time T_{Don} vs. R_G

NXH25T120L2Q1PG

TYPICAL CHARACTERISTICS – HALF BRIDGE IGBT COMUTATES NEUTRAL POINT DIODE

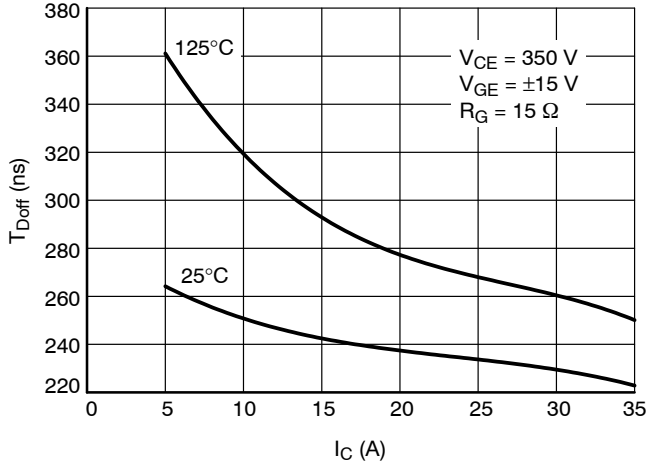

Figure 28. Typical Switching Time T_{Doff} vs. I_C

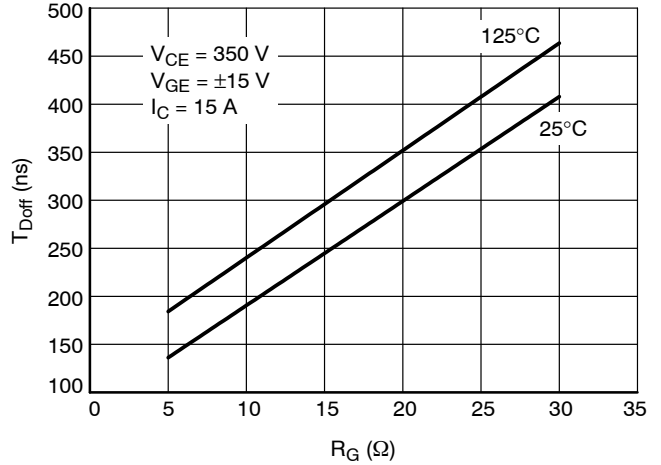

Figure 29. Typical Switching Time T_{Doff} vs. R_G

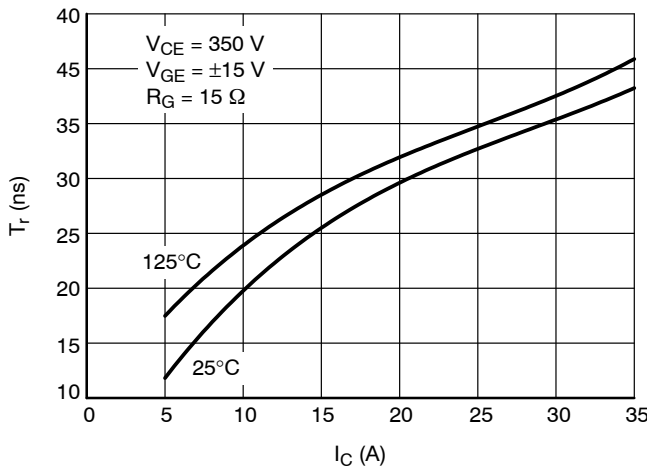

Figure 30. Typical Switching Time T_r vs. I_C

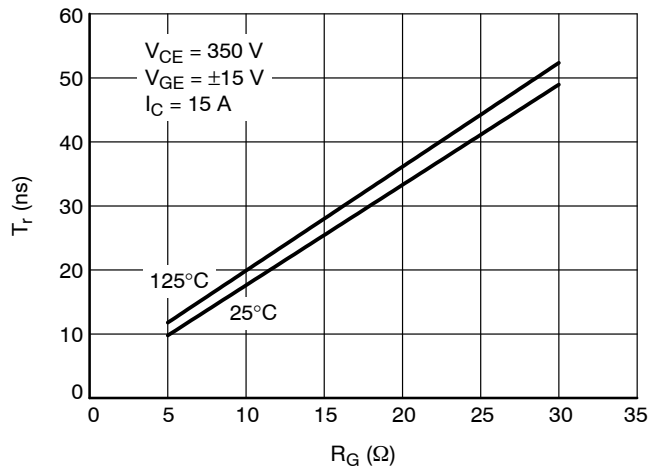

Figure 31. Typical Switching Time T_r vs. R_G

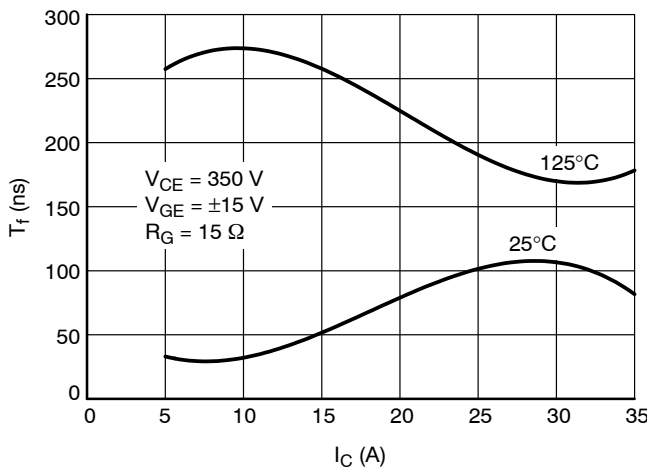

Figure 32. Typical Switching Time T_f vs. I_C

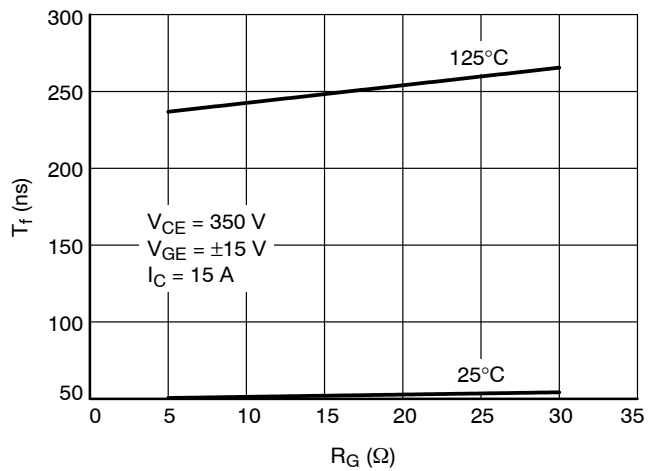

Figure 33. Typical Switching Time T_f vs. R_G

TYPICAL CHARACTERISTICS – HALF BRIDGE IGBT COMUTATES NEUTRAL POINT DIODE

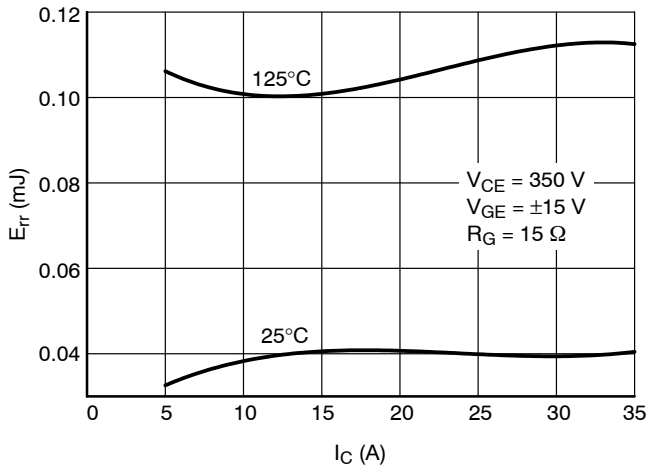

Figure 34. Typical Reverse Recovery Energy vs. I_C

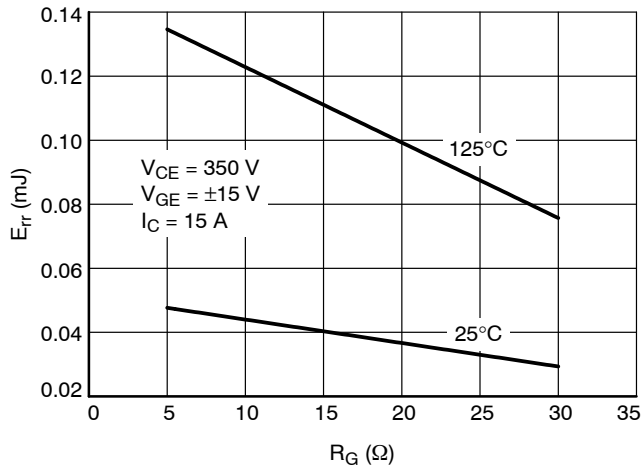

Figure 35. Typical Reverse Recovery Energy vs. R_G

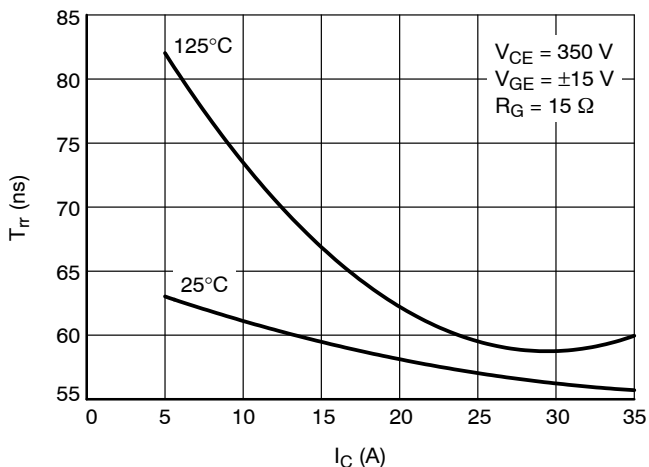

Figure 36. Typical Reverse Recovery Time vs. I_C

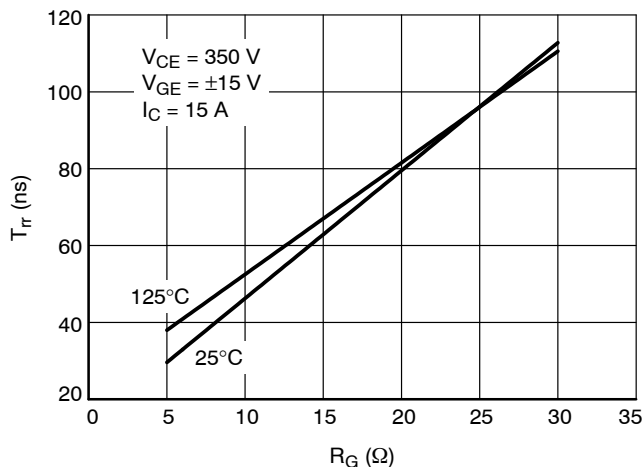

Figure 37. Typical Reverse Recovery Time vs. R_G

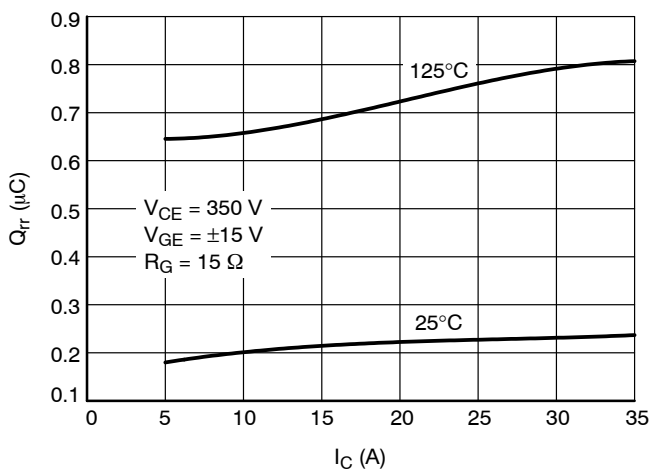

Figure 38. Typical Reverse Recovery Charge vs. I_C

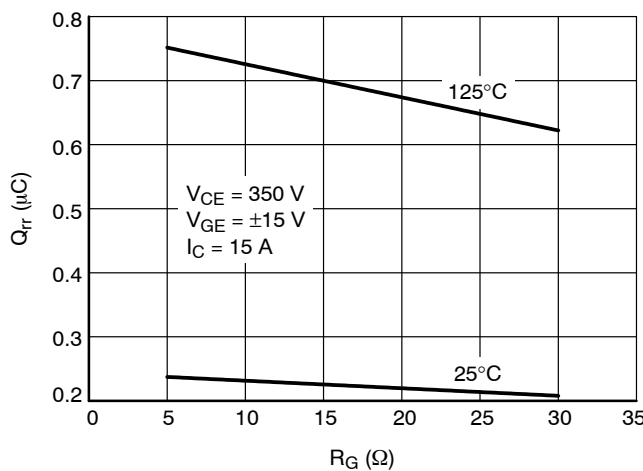

Figure 39. Typical Reverse Recovery Charge vs. R_G

TYPICAL CHARACTERISTICS – HALF BRIDGE IGBT COMUTATES NEUTRAL POINT DIODE

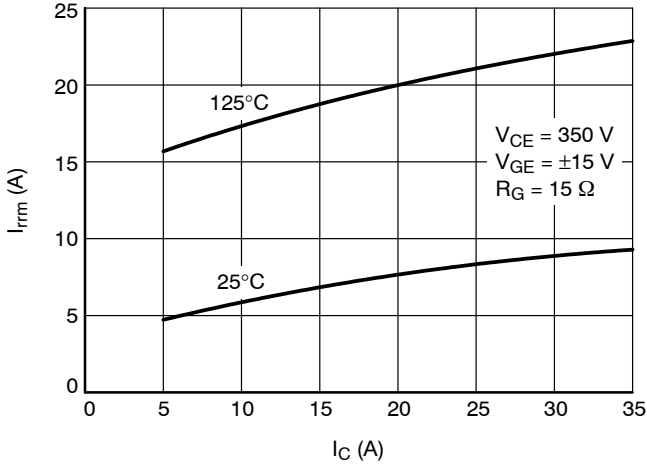

Figure 40. Typical Reverse Recovery Current vs. I_C

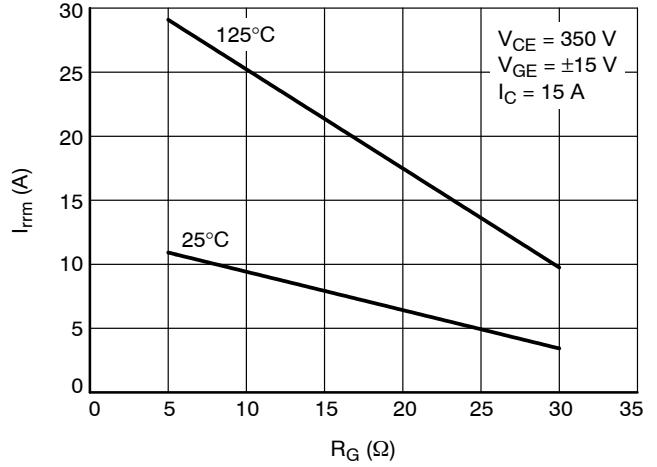

Figure 41. Typical Reverse Recovery Current vs. R_G

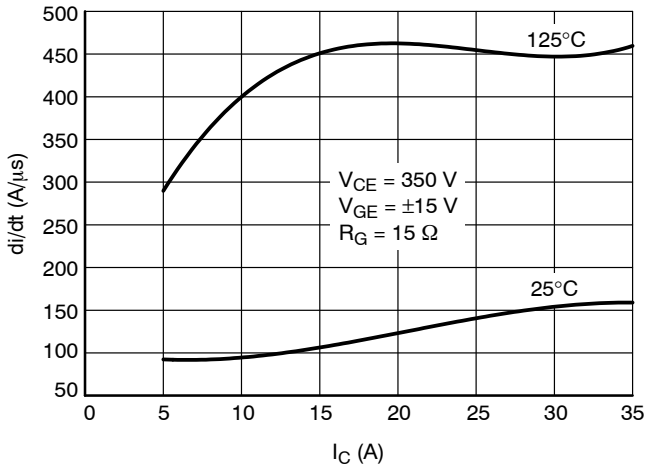

Figure 42. Typical di/dt vs. I_C

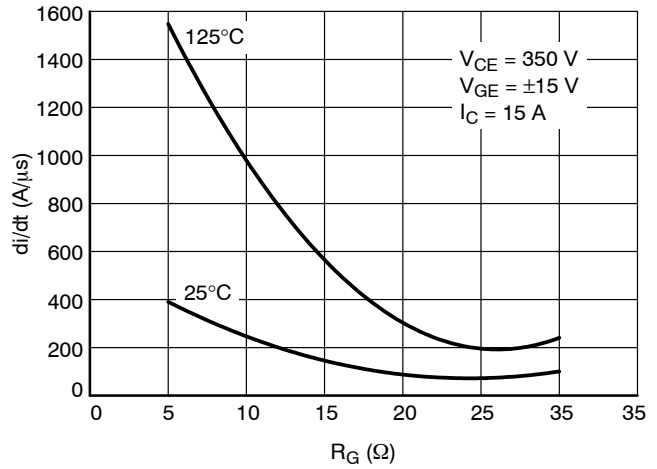

Figure 43. Typical di/dt vs. R_G

NXH25T120L2Q1PG

TYPICAL CHARACTERISTICS – NEUTRAL POINT IGBT COMUTATES HALF BRIDGE DIODE

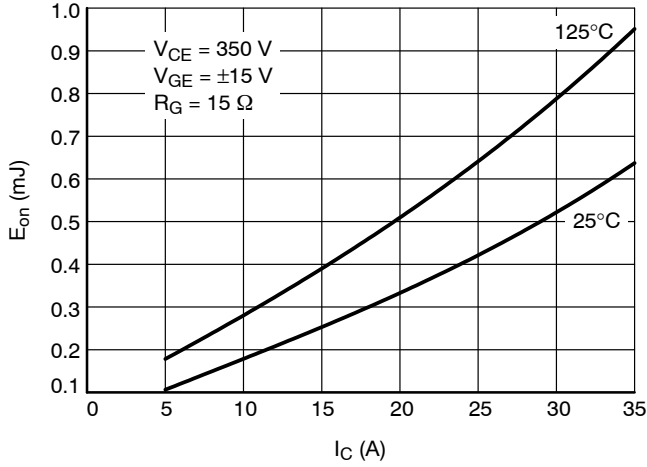

Figure 44. Typical Switching Energy E_{on} vs. I_C

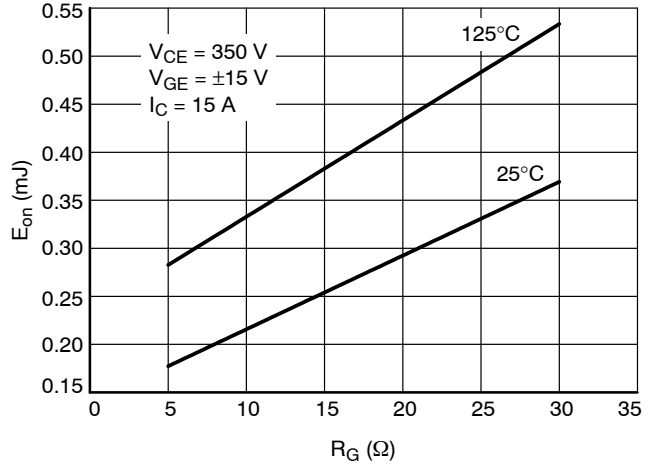

Figure 45. Typical Switching Energy E_{on} vs. R_G

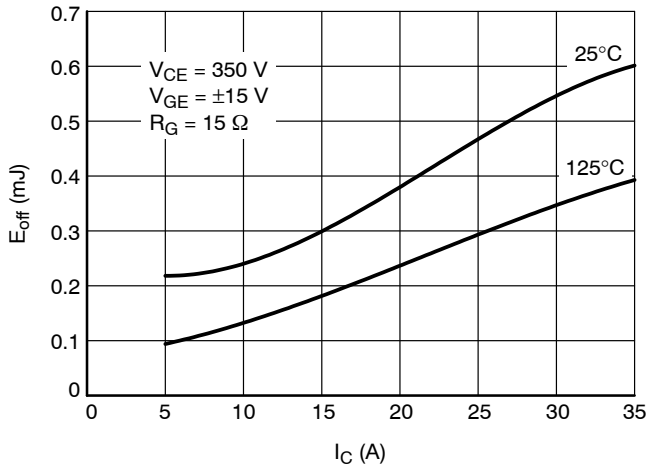

Figure 46. Typical Switching Energy E_{off} vs. I_C

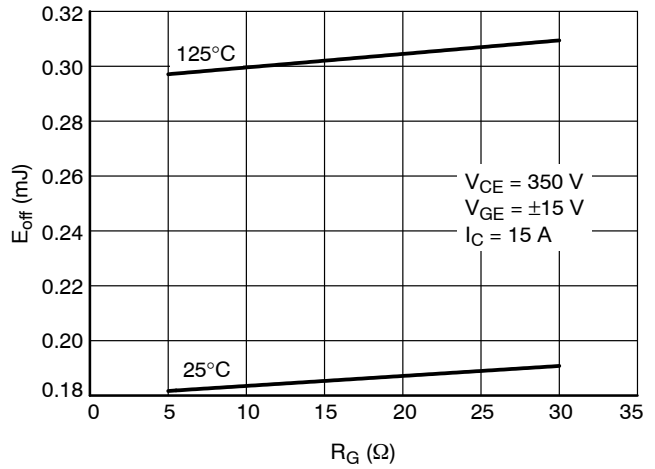

Figure 47. Typical Switching Energy E_{off} vs. R_G

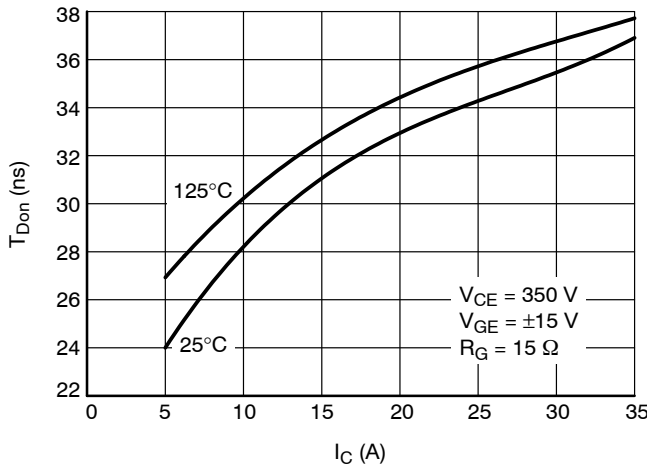

Figure 48. Typical Switching Time T_{Don} vs. I_C

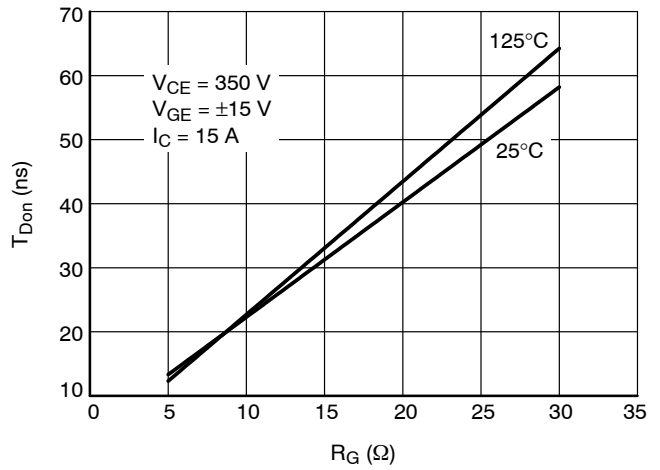

Figure 49. Typical Switching Time T_{Don} vs. R_G

NXH25T120L2Q1PG

TYPICAL CHARACTERISTICS – NEUTRAL POINT IGBT COMUTATES HALF BRIDGE DIODE

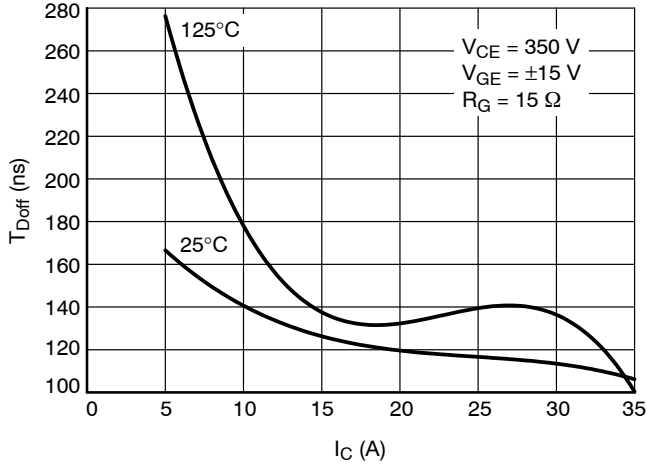

Figure 50. Typical Switching Time T_{Doff} vs. I_C

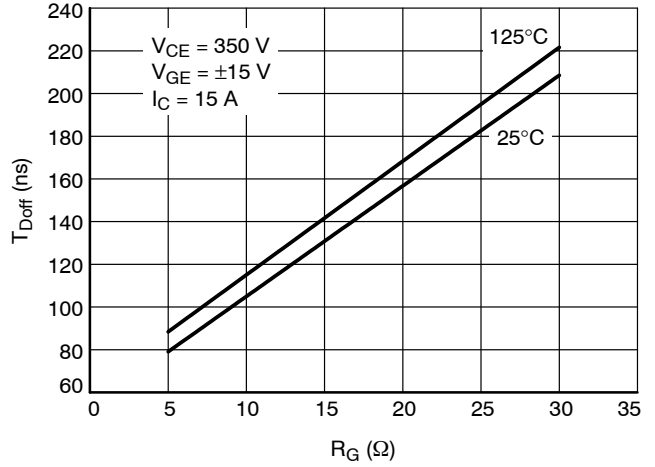

Figure 51. Typical Switching Time T_{Doff} vs. R_G

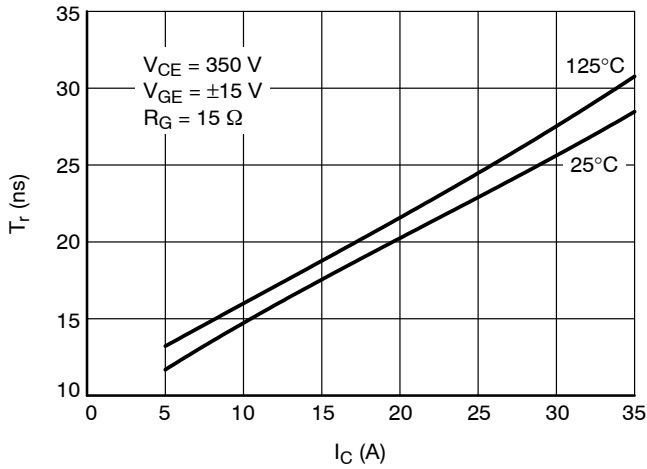

Figure 52. Typical Switching Time T_r vs. I_C

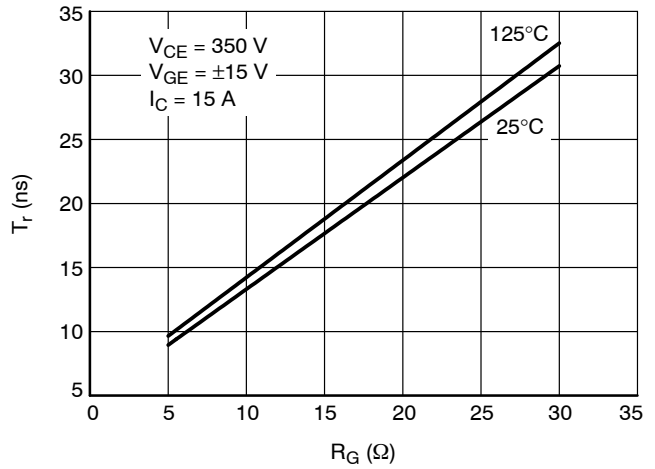

Figure 53. Typical Switching Time T_r vs. R_G

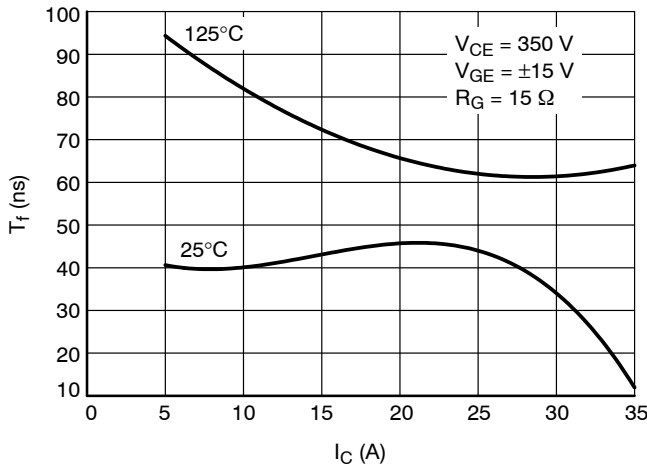

Figure 54. Typical Switching Time T_f vs. I_C

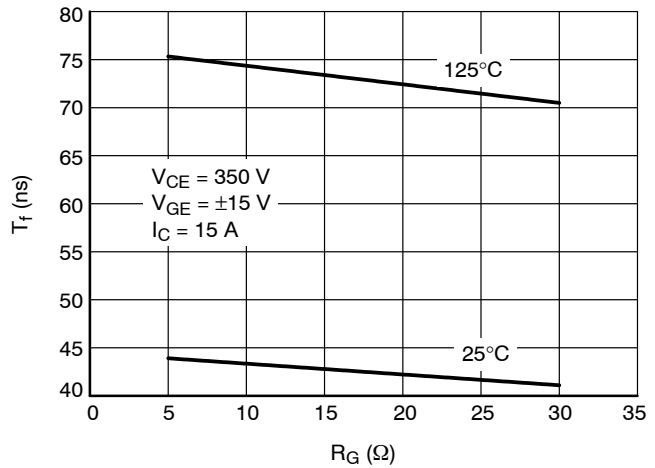

Figure 55. Typical Switching Time T_f vs. R_G

TYPICAL CHARACTERISTICS – NEUTRAL POINT IGBT COMUTATES HALF BRIDGE DIODE

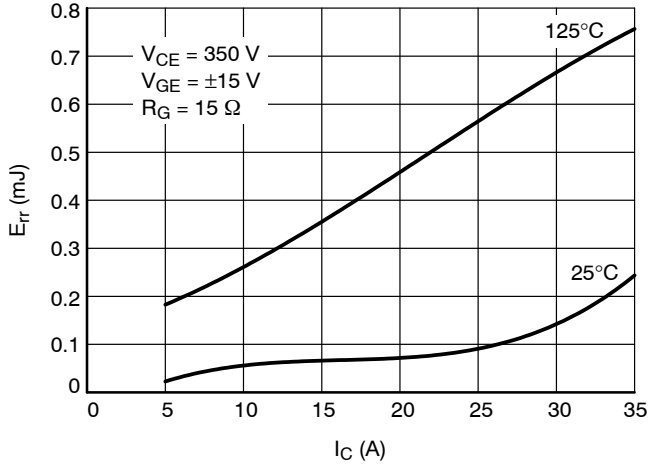

Figure 56. Typical Reverse Recovery Energy vs. I_C

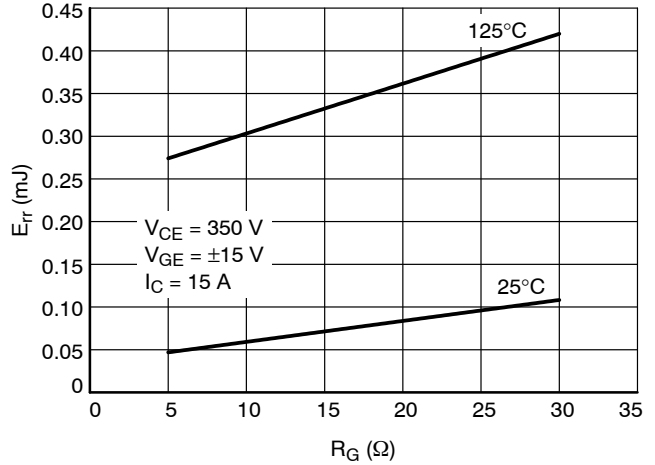

Figure 57. Typical Reverse Recovery Energy vs. R_G

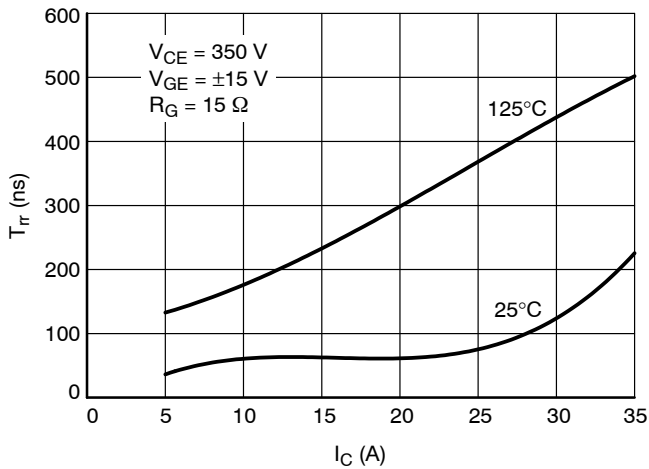

Figure 58. Typical Reverse Recovery Time vs. I_C

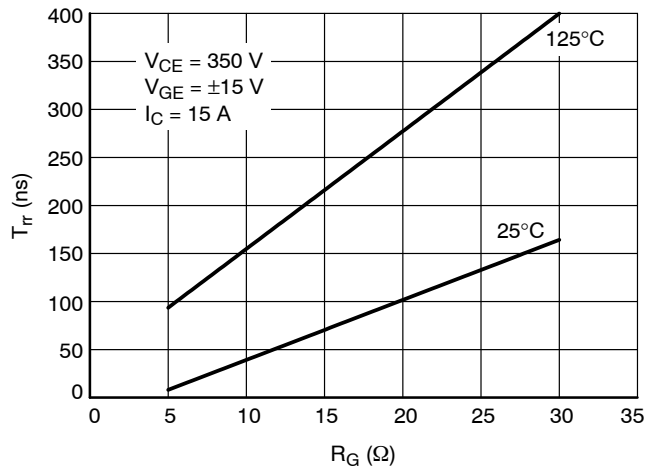

Figure 59. Typical Reverse Recovery Time vs. R_G

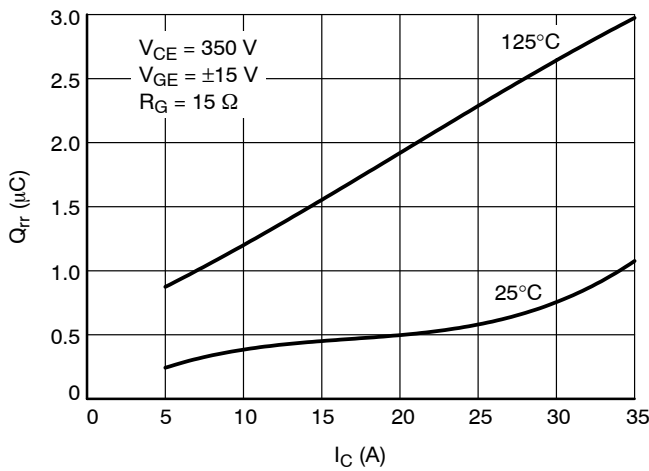

Figure 60. Typical Reverse Recovery Charge vs. I_C

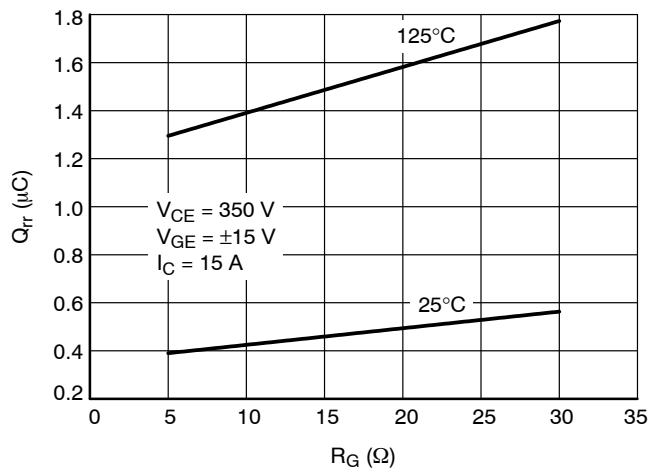

Figure 61. Typical Reverse Recovery Charge vs. R_G

NXH25T120L2Q1PG

TYPICAL CHARACTERISTICS – NEUTRAL POINT IGBT COMUTATES HALF BRIDGE DIODE

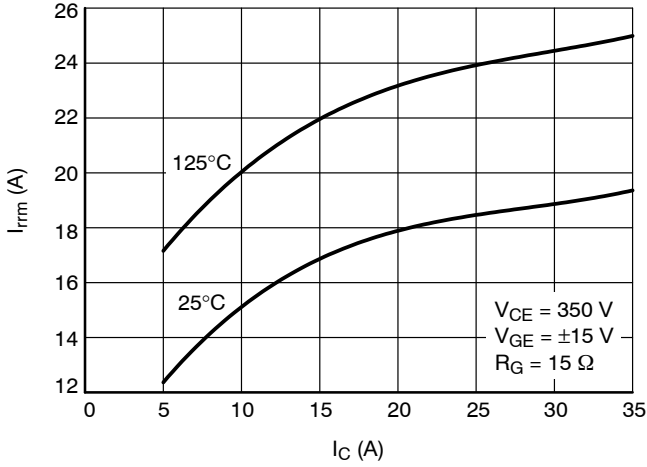

Figure 62. Typical Reverse Recovery Current vs. I_C

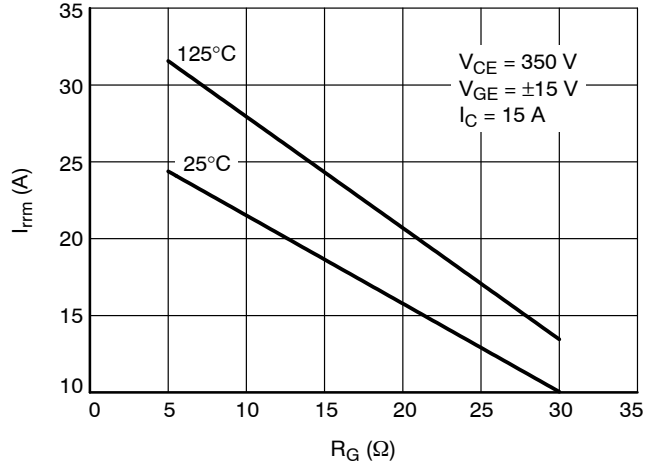

Figure 63. Typical Reverse Recovery Current vs. R_G

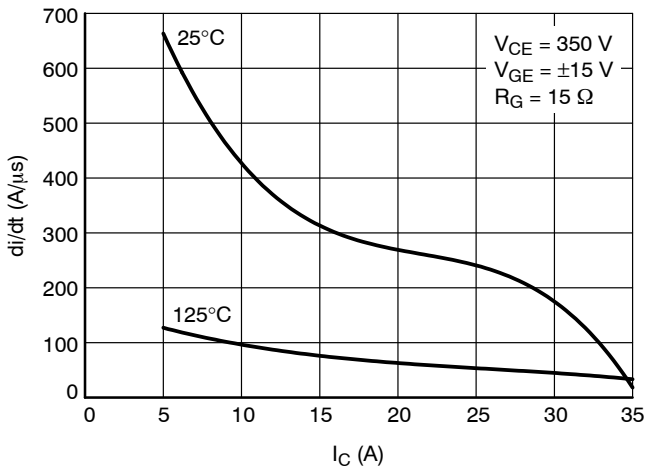

Figure 64. Typical di/dt vs. I_C

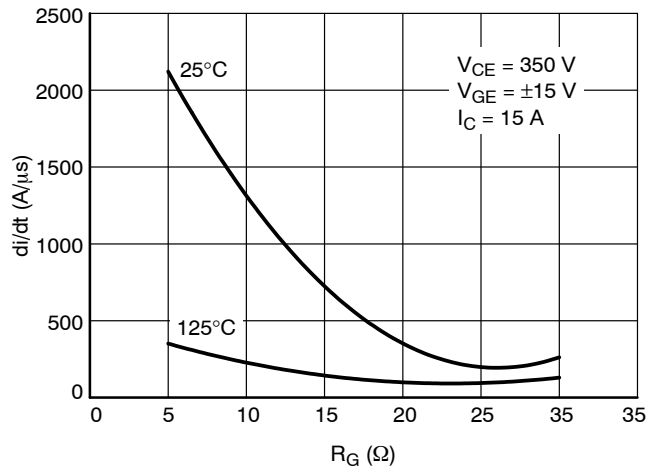

Figure 65. Typical di/dt vs. R_G

MECHANICAL CASE OUTLINE PACKAGE DIMENSIONS

ON Semiconductor®



PIM44, 71x37.4
CASE 180AS
ISSUE O

DATE 25 JUN 2018

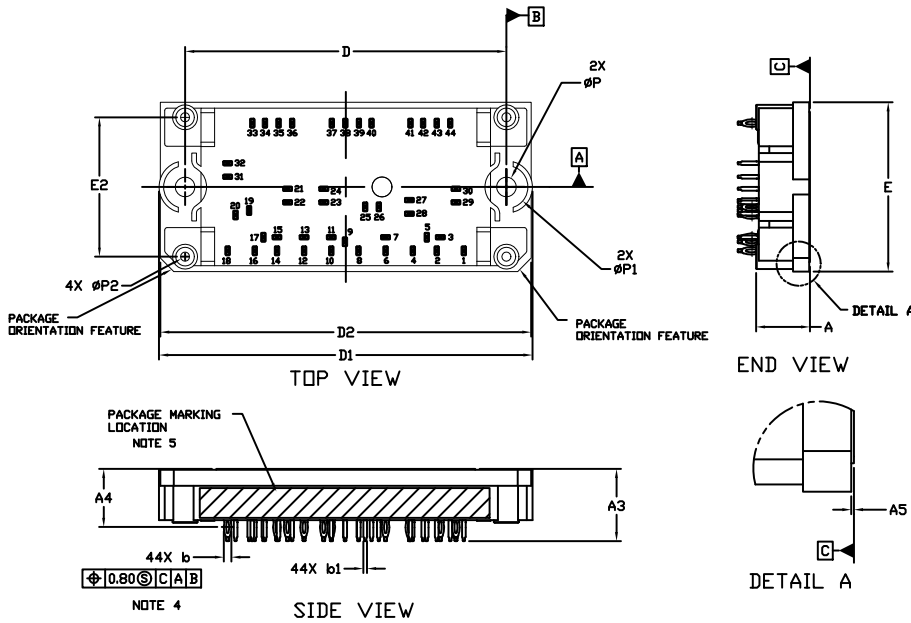

PIN	PIN POSITION		PIN	PIN POSITION	
	X	Y		X	Y
1	26.10	14.10	23	-4.85	3.40
2	20.10	14.10	24	-4.85	0.40
3	20.90	11.10	25	4.30	4.40
4	14.80	14.10	26	7.30	4.40
5	17.90	11.10	27	14.05	2.90
6	8.80	14.10	28	14.05	5.90
7	8.80	11.10	29	24.35	3.40
8	2.80	14.10	30	24.35	0.40
9	-0.20	12.10	31	-26.10	-2.25
10	-3.20	14.10	32	-26.10	-5.25
11	-3.20	11.10	33	-20.65	-14.10
12	-9.20	14.10	34	-17.85	-14.10
13	-9.20	11.10	35	-14.85	-14.10
14	-15.20	14.10	36	-11.85	-14.10
15	-15.20	11.10	37	-3.10	-14.10
16	-20.10	14.10	38	-0.10	-14.10
17	-18.20	11.10	39	2.90	-14.10
18	-26.10	14.10	40	5.70	-14.10
19	-21.35	5.20	41	14.30	-14.10
20	-24.35	6.20	42	17.10	-14.10
21	-12.85	0.40	43	20.10	-14.10
22	-12.85	3.40	44	23.10	-14.10

NOTE 4

PIN	PIN POSITION		PIN	PIN POSITION	
	X	Y		X	Y
1	26.10	-14.10	23	-4.85	-3.40
2	20.10	-14.10	24	-4.85	-0.40
3	20.90	-11.10	25	4.30	-4.40
4	14.80	-14.10	26	7.30	-4.40
5	17.90	-11.10	27	14.05	-2.90
6	8.80	-14.10	28	14.05	-5.90
7	8.80	-11.10	29	24.35	-3.40
8	2.80	-14.10	30	24.35	-0.40
9	-0.20	-12.10	31	-26.10	2.25
10	-3.20	-14.10	32	-26.10	5.25
11	-3.20	-11.10	33	-20.65	14.10
12	-9.20	-14.10	34	-17.85	14.10
13	-9.20	-11.10	35	-14.85	14.10
14	-15.20	-14.10	36	-11.85	14.10
15	-15.20	-11.10	37	-3.10	14.10
16	-20.10	-14.10	38	-0.10	14.10
17	-18.20	-11.10	39	2.90	14.10
18	-26.10	-14.10	40	5.70	14.10
19	-21.35	-5.20	41	14.30	14.10
20	-24.35	-6.20	42	17.10	14.10
21	-12.85	-0.40	43	20.10	14.10
22	-12.85	-3.40	44	23.10	14.10

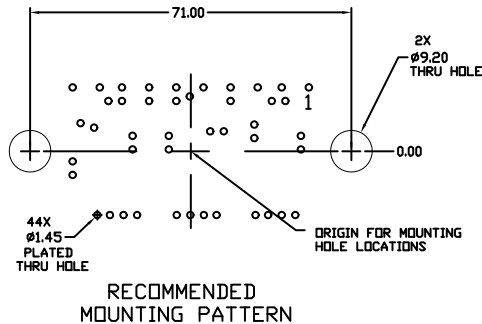

DIM	MILLIMETERS		
	MIN.	NDM.	MAX.
A	11.50	12.00	12.50
A3	15.50	16.00	16.50
A4	12.83 BSC		
A5	0.10	0.20	0.30
b	1.61	1.66	1.71
b1	0.75	0.80	0.85
D	70.50	71.00	71.50
D1	82.00	82.50	83.00
D2	81.50	82.00	82.50
E	36.90	37.40	37.90
E2	30.30	30.80	31.30
P	4.10	4.30	4.50
P1	9.30	9.50	9.70
P2	1.80	2.00	2.20

NOTES:

- DIMENSIONING AND TOLERANCING PER ASME Y14.5M, 2009.
- CONTROLLING DIMENSION: MILLIMETERS
- DIMENSIONS b AND b1 APPLY TO THE PLATED TERMINALS AND ARE MEASURED AT DIMENSION A4.
- POSITION OF THE CENTER OF THE TERMINALS IS DETERMINED FROM DATUM B THE CENTER OF DIMENSION D, X DIRECTION, AND FROM DATUM A, Y DIRECTION. POSITIONAL TOLERANCE, AS NOTED IN DRAWING, APPLIES TO EACH TERMINAL IN BOTH DIRECTIONS.
- PACKAGE MARKING IS LOCATED AS SHOWN ON THE SIDE OPPOSITE THE PACKAGE ORIENTATION FEATURES.

DOCUMENT NUMBER:	98AON92314G	Electronic versions are uncontrolled except when accessed directly from the Document Repository. Printed versions are uncontrolled except when stamped "CONTROLLED COPY" in red.
DESCRIPTION:	PIM44, 71x37.4	PAGE 1 OF 2

ON Semiconductor and are trademarks of Semiconductor Components Industries, LLC dba ON Semiconductor or its subsidiaries in the United States and/or other countries. ON Semiconductor reserves the right to make changes without further notice to any products herein. ON Semiconductor makes no warranty, representation or guarantee regarding the suitability of its products for any particular purpose, nor does ON Semiconductor assume any liability arising out of the application or use of any product or circuit, and specifically disclaims any and all liability, including without limitation special, consequential or incidental damages. ON Semiconductor does not convey any license under its patent rights nor the rights of others.

PIM44, 71x37.4
CASE 180AS
ISSUE 0

DATE 15 JUN 2018

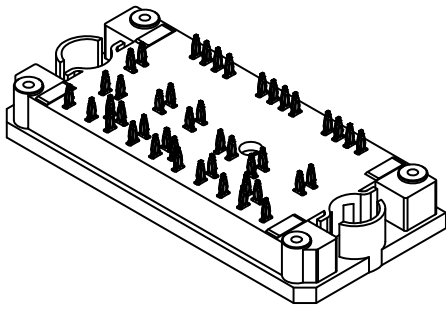

**GENERIC
MARKING DIAGRAM***

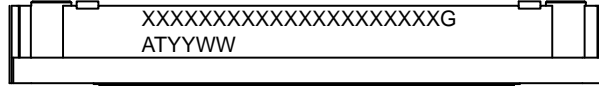

XXXXX = Specific Device Code
G = Pb-Free Package
AT = Assembly & Test Site Code
YYWW = Year and Work Week Code

*This information is generic. Please refer to device data sheet for actual part marking. Pb-Free indicator, "G" or microdot "▪", may or may not be present. Some products may not follow the Generic Marking.

DOCUMENT NUMBER:	98AON92314G	Electronic versions are uncontrolled except when accessed directly from the Document Repository. Printed versions are uncontrolled except when stamped "CONTROLLED COPY" in red.
DESCRIPTION:	PIM44, 71x37.4	PAGE 2 OF 2

ON Semiconductor and  are trademarks of Semiconductor Components Industries, LLC dba ON Semiconductor or its subsidiaries in the United States and/or other countries. ON Semiconductor reserves the right to make changes without further notice to any products herein. ON Semiconductor makes no warranty, representation or guarantee regarding the suitability of its products for any particular purpose, nor does ON Semiconductor assume any liability arising out of the application or use of any product or circuit, and specifically disclaims any and all liability, including without limitation special, consequential or incidental damages. ON Semiconductor does not convey any license under its patent rights nor the rights of others.

www.onsemi.com

onsemi, **Onsemi**, and other names, marks, and brands are registered and/or common law trademarks of Semiconductor Components Industries, LLC dba "**onsemi**" or its affiliates and/or subsidiaries in the United States and/or other countries. **onsemi** owns the rights to a number of patents, trademarks, copyrights, trade secrets, and other intellectual property. A listing of **onsemi**'s product/patent coverage may be accessed at www.onsemi.com/site/pdf/Patent-Marking.pdf. **onsemi** reserves the right to make changes at any time to any products or information herein, without notice. The information herein is provided "as-is" and **onsemi** makes no warranty, representation or guarantee regarding the accuracy of the information, product features, availability, functionality, or suitability of its products for any particular purpose, nor does **onsemi** assume any liability arising out of the application or use of any product or circuit, and specifically disclaims any and all liability, including without limitation special, consequential or incidental damages. Buyer is responsible for its products and applications using **onsemi** products, including compliance with all laws, regulations and safety requirements or standards, regardless of any support or applications information provided by **onsemi**. "Typical" parameters which may be provided in **onsemi** data sheets and/or specifications can and do vary in different applications and actual performance may vary over time. All operating parameters, including "Typicals" must be validated for each customer application by customer's technical experts. **onsemi** does not convey any license under any of its intellectual property rights nor the rights of others. **onsemi** products are not designed, intended, or authorized for use as a critical component in life support systems or any FDA Class 3 medical devices or medical devices with a same or similar classification in a foreign jurisdiction or any devices intended for implantation in the human body. Should Buyer purchase or use **onsemi** products for any such unintended or unauthorized application, Buyer shall indemnify and hold **onsemi** and its officers, employees, subsidiaries, affiliates, and distributors harmless against all claims, costs, damages, and expenses, and reasonable attorney fees arising out of, directly or indirectly, any claim of personal injury or death associated with such unintended or unauthorized use, even if such claim alleges that **onsemi** was negligent regarding the design or manufacture of the part. **onsemi** is an Equal Opportunity/Affirmative Action Employer. This literature is subject to all applicable copyright laws and is not for resale in any manner.

ADDITIONAL INFORMATION

TECHNICAL PUBLICATIONS:

Technical Library: www.onsemi.com/design/resources/technical-documentation
onsemi Website: www.onsemi.com

ONLINE SUPPORT: www.onsemi.com/support

For additional information, please contact your local Sales Representative at www.onsemi.com/support/sales